

**DCS**  
SERIES

  
THE FIGHTER COLLECTION  Eagle Dynamics

*Mustang*

*P-51D*



**DCS: P-51D MUSTANG**  
**Flight Manual**

Dear User,

Thank you for your purchase of DCS: P-51D Mustang! DCS: P-51D is a simulation of the legendary American World War II fighter, the P-51 Mustang, and is the third installment in the Digital Combat Simulator (DCS) series of PC combat simulations.

Like previous DCS titles, DCS: P-51D features a painstakingly reproduced model of the aircraft, including the external model and cockpit, as well as all of the mechanical systems and aerodynamic properties. At the same time, DCS: P-51D offers an entirely new experience in the DCS world by placing you behind the controls of a powerful, propeller-driven, piston engine combat aircraft. Designed long before “fly-by-wire” technology was available to assist the pilot in flight control or smart bombs and beyond visual range missiles were developed to engage targets with precision from afar, the Mustang is a personal and exhilarating challenge to master. As elegant as it is powerful, the P-51 unites man and machine in the magic of flight and the deadly force of combat aviation.

As operators of one of the largest collections of restored World War II aircraft, we at The Fighter Collection and the development team at Eagle Dynamics were fortunate to be able to take advantage of our own actual P-51D and its pilots to ensure the DCS model is one of the most accurate virtual reproductions of this aircraft ever made. Combined with volumes of outside research and documentation, the field trips to the TFC hangar and countless consultations and tests by TFC pilots were invaluable in the creation of this simulation.

The contents of this manual are based largely on actual vintage P-51D manuals of the aircraft’s service era.

With homage to the brave pilots of World War II, we hope you enjoy taking this true Flying Legend to the skies and into the fight!

Sincerely,

The DCS: P-51D Mustang Development Team

DCS: [www.digitalcombatsimulator.com](http://www.digitalcombatsimulator.com)

Forum: <http://forums.eagle.ru>

© 2012-2015 The Fighter Collection

© 2012-2015 Eagle Dynamics

**All trademarks and registered trademarks** are the property of their respective owners

# TABLE OF CONTENTS

<b>AN OLD INDIAN LEGEND</b> .....	<b>11</b>
<b>INTRODUCTION</b> .....	<b>13</b>
<b>AIRCRAFT OVERVIEW</b> .....	<b>18</b>
GENERAL DESCRIPTION .....	18
<i>Specifications</i> .....	18
P-51D MAJOR ASSEMBLY PARTS .....	20
FUSELAGE .....	22
<i>Canopy</i> .....	22
WING.....	23
TAIL SECTION.....	26
FLIGHT CONTROLS .....	26
<i>Surface Control Lock</i> .....	27
LANDING GEAR .....	27
BRAKE SYSTEM.....	29
ENGINE.....	30
<i>Supercharger</i> .....	32
<i>Carburetor</i> .....	33
<i>War Emergency Power</i> .....	34
PROPELLER .....	35
FUEL SYSTEM.....	36
HYDRAULIC SYSTEM .....	39
OIL SYSTEM.....	40
COOLANT SYSTEM .....	42
ELECTRICAL SYSTEM .....	44
OXYGEN SYSTEM .....	45
<i>Approximate Oxygen Supply</i> .....	46
ENVIRONMENTAL SYSTEMS.....	47
RADIO EQUIPMENT .....	48

ARMOR .....	49
ARMAMENT .....	50
<b>COCKPIT.....</b>	<b>54</b>
FRONT DASH LEGEND.....	55
LEFT SIDE LEGEND .....	57
RIGHT SIDE LEGEND .....	58
FRONT DASH INDICATORS AND CONTROLS .....	59
<i>K-14 Gunsight</i> .....	59
<i>Instrument Panel</i> .....	61
<i>Vacuum System Instruments</i> .....	62
<i>Pitot Static System Instruments</i> .....	64
<i>Engine Instruments</i> .....	67
<i>Miscellaneous Instruments</i> .....	70
<i>Engine Control Panel</i> .....	74
<i>Front Switch Panel</i> .....	76
<i>Fuel Shutoff and Selector Valves</i> .....	78
<i>Landing Gear Warning Lights</i> .....	79
<i>Parking Brake</i> .....	80
LEFT SIDE CONTROLS.....	82
<i>Throttle Quadrant</i> .....	82
<i>Radiator Air Control Panel</i> .....	84
<i>Trim Tab Controls</i> .....	86
<i>Carburetor Air Controls</i> .....	87
<i>Flaps Control</i> .....	88
<i>Bomb Salvo Handles</i> .....	88
<i>Landing Gear Handle</i> .....	89
RIGHT SIDE CONTROLS .....	91
<i>Canopy Controls</i> .....	91
<i>Oxygen Regulator</i> .....	91
<i>Recognition Lights</i> .....	92

<i>Electrical Control Panel</i> .....	93
<i>AN/APS-13 Rear Warning Radar</i> .....	95
<i>SCR-522-A VHF Radio</i> .....	96
<i>SCR-695-A IFF Radio</i> .....	97
<i>AN/ARA-8 Homing Adapter</i> .....	98
<i>BC-1206 "Detrola" Radio Range Receiver</i> .....	99
COCKPIT HEATING AND VENTILATING CONTROLS .....	100
KNEEBOARD MAP .....	101
<b>FLIGHT CHARACTERISTICS</b> .....	<b>103</b>
GENERAL CHARACTERISTICS .....	103
OPERATING LIMITS .....	104
<i>Load Factor Limitations</i> .....	104
<i>Engine Limitations</i> .....	105
<i>Airspeed Limitations</i> .....	105
<i>Instrument Markings</i> .....	106
SPECIAL FLIGHT CONDITIONS .....	110
<i>Full Fuselage Tank</i> .....	110
<i>Reversibility</i> .....	110
<i>Drop Tanks</i> .....	110
<i>Low Level Flight</i> .....	110
<i>High Altitude Flight Characteristics</i> .....	110
<i>High Speed Dives</i> .....	111
<i>Maximum Indicated Airspeed</i> .....	112
<i>Compressibility</i> .....	113
<i>Glides</i> .....	114
<i>Stalls</i> .....	115
<i>Spins</i> .....	116
<i>High Performance Maneuvers</i> .....	116
<i>Instrument Flying</i> .....	117
<i>Icing</i> .....	118

<b>NORMAL PROCEDURES</b> .....	<b>120</b>
EXTERNAL CHECK .....	120
PRE-START .....	120
START-UP .....	127
STOPPING THE ENGINE .....	129
TAXIING.....	130
PREFLIGHT CHECK.....	131
TAKEOFF.....	132
<i>Normal Takeoff</i> .....	132
<i>Minimum-Run Takeoff</i> .....	133
<i>Crosswind Takeoff</i> .....	133
<i>After Takeoff</i> .....	133
LANDING .....	134
<i>Descent</i> .....	134
<i>Approach Check</i> .....	134
<i>Landing Procedure</i> .....	134
AFTER LANDING .....	136
SPECIAL LANDING CONDITIONS .....	137
<i>Crosswind Landings</i> .....	137
<i>Gusty Landings</i> .....	137
<i>Wet Landings</i> .....	137
LANDING GO-AROUND.....	137
COLD WEATHER OPERATION .....	138
<i>Starting the Engine</i> .....	138
<i>Before Takeoff</i> .....	138
<i>Takeoff</i> .....	139
<i>After Takeoff</i> .....	139
<i>Engine Operation in Flight</i> .....	139
<i>Systems Operation in Flight</i> .....	139
<i>Approach</i> .....	139

<b>EMERGENCY PROCEDURES</b> .....	<b>141</b>
ENGINE EMERGENCIES .....	141
<i>Engine Overheating</i> .....	141
<i>Engine Failure</i> .....	141
<i>Runaway Propellers</i> .....	143
FIRE .....	144
LANDING EMERGENCIES .....	144
<i>Forced Landing Over Doubtful Terrain</i> .....	144
<i>Belly Landing</i> .....	144
<i>Forced Landing at Night</i> .....	145
BRAKE FAILURE .....	145
HYDRAULIC SYSTEM FAILURE .....	145
ELECTRICAL SYSTEM FAILURE .....	146
TIRE FAILURE .....	147
DITCHING .....	147
<i>Radio Procedure</i> .....	147
<i>Approach and Touchdown</i> .....	148
BAILING OUT .....	148
<i>Bailout at High Altitude</i> .....	149
<i>Bailout in a Spin</i> .....	149
<i>Bailout over Water</i> .....	149
<b>COMBAT EMPLOYMENT</b> .....	<b>151</b>
GUNS .....	151
<i>Aiming with the K-14 Gunsight</i> .....	151
<i>Target Pattern. Right and Wrong</i> .....	154
<i>Pre-flight Check of the K-14 Gunsight</i> .....	155
<i>Firing Guns with the K-14 Gunsight</i> .....	156
BOMBS .....	156
<i>Releasing Bombs</i> .....	156
<i>Emergency Bomb and Drop Tank Release</i> .....	156

ROCKETS.....	156
<i>Firing Rockets</i> .....	157
<b>RADIO COMMUNICATIONS .....</b>	<b>159</b>
<i>Easy Communication is enabled</i> .....	159
<i>Easy Communication is not enabled</i> .....	160
RADIO COMMUNICATIONS WINDOW .....	160
F1 WINGMAN .....	160
<i>F1 Navigation</i> .....	161
<i>F2 Engage</i> .....	161
<i>F3 Engage With</i> .....	162
<i>F4 Maneuvers</i> .....	163
<i>F5 Rejoin Formation</i> .....	163
F2 FLIGHT.....	163
<i>F1 Navigation</i> .....	163
<i>F2 Engage</i> .....	164
<i>F3 Engage With</i> .....	164
<i>F4 Maneuvers</i> .....	164
<i>F5 Formation</i> .....	165
<i>F6 Rejoin Formation</i> .....	170
F3 SECOND ELEMENT .....	170
<i>F1 Navigation</i> .....	171
<i>F2 Engage</i> .....	171
<i>F3 Engage with</i> .....	172
<i>F4 Maneuvers</i> .....	172
<i>F5 Rejoin Formation</i> .....	172
FLIGHT MEMBER RESPONSES.....	172
F4 JTAC.....	173
F5 ATC.....	176
F7 AWACS .....	178
F8 GROUND CREW .....	178



---

<b>SUPPLEMENTS</b> .....	<b>180</b>
AIRBASE DATA .....	180
MORSE CODE ALPHABET.....	181
DEVELOPERS .....	184
EAGLE DYNAMICS .....	184
<i>Management</i> .....	184
<i>Programmers</i> .....	184
<i>Artists and Sound</i> .....	185
<i>Quality Assurance</i> .....	186
<i>Science Support</i> .....	186
<i>IT and Customer Support</i> .....	186
<i>Third Parties</i> .....	187
<i>Tester staff</i> .....	187
<i>Special thanks</i> .....	188

# AN OLD INDIAN LEGEND



## AN OLD INDIAN LEGEND

*Once upon a time, long ago, when his tribe was at war, a young Indian brave was called to the tepee of his eldest uncle. "My son," said the uncle, who was one of the chiefs of the tribe, "you are needed to join our warriors in the fight. You haven't many years, but you are strong of body and quick of mind. And you are greatly needed. So I have decided to bestow upon you a great honor," continued the uncle. "You are to have the finest stallion in my herd – that beautiful young mustang from the western plains."*

*The boy's face glowed with delight. For well he knew that only the luckiest among the tribe were privileged to go forth to battle on the speedy, spirited, and durable little mustangs.*

*"But it will take time to master this stallion," warned the uncle. "You will have to work hard and long and patiently with the animal. And you will not be allowed to join your elders against the enemy until you have proven well that you can handle him."*

*In the days that followed, the young brave was the envy of all eyes, for the mustang was a beauty to behold and one of the fastest horses of the tribe. Now this made the young brave all the more eager. So in just a few weeks he returned to his uncle saying, "I am ready to join the fight."*

*The chief took the young brave, proud upon his fiery mustang, to a great clearing in the woods to see how well he and his newly broken stallion could perform. In the very first tests where the going was rough, the boy landed in a heap on the ground.*

*"My son," said the uncle, "you have disregarded my warning. There is no finer horse in all our herds than the one I have given you. But it is fast, and full of power and destruction. And it must be made to know that you are its master. Or, as you have learned, you will not be riding the animal long."*

*In the days that followed, the chastened young brave worked diligently with his stallion. He now respected its speed and daring which were his to command. And though confident, he never bragged of his prowess. In due time, the uncle, wise in the ways of the world, put the boy once again to the test. On this occasion the young brave had the mustang completely under his control. He had worked hard and long, because he really wanted to succeed. Man and animal performed as one, the beautiful stallion responding to the slightest command of the rider in a manner that warmed the heart of the aged uncle.*

*In the years that followed, the young brave, with his unrivaled mustang under perfect control, performed brilliantly in fight after fight. Enemy braves, riding lesser animals, could never match his masterful performances. None could outride him; none could outwit him. The young brave's deeds became legendary. And he lived to be a very old man and had many offspring – who never tired of relating the heroic deeds of the famous forbearer.*

# INTRODUCTION



U.S. ARMY PSIC-10-NA-A  
SERIAL NO. 43-25147  
CREW WEIGHT 200 LBS.

SPECIAL PROJECT NO.  
SERVICE THIS AIRPLANE WITH  
GRADE 100/130 FUEL IF NOT  
AVAILABLE T.O. 09-5-1 WILL BE  
CONSULTED FOR EMERGENCY ACTION  
SUITABLE FOR AROMATIC FUEL.

H

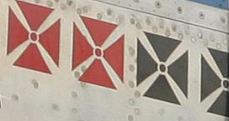

## INTRODUCTION

Like the Indian braves of the old southwest whose favorite in battle was the small speedy Mustang, young fighter pilots of World War II, with their newly won wings, almost without exception wanted to fly the famous namesake of that sleek and powerful war horse, the P-51.

And no wonder, for the P-51 is truly a pilot's aircraft. In mission after mission it had proved that it could more than hold its own against any opposition. Its speed and range were at the tops. It operated effectively on the deck and all the way up to 40,000 feet. In maneuverability and load-carrying capacity, it ranked with any other fighter in the world.

The P-51 was the first aircraft of the war to be built entirely on the basis of combat experience. Its design was started by North American Aviation (NAA) after the Luftwaffe had begun to overwhelm Europe – and many lessons had already been learned about modern aerial warfare from actual experience.

The P-51 was initially conceived when NAA was approached by the British in 1940 to license produce their P-40's on order from Curtiss-Wright Corporation. NAA's president responded that the company could instead produce its own, better fighter aircraft in the same time it would take to prepare for the production of the P-40. The first prototype, designated NA-73X, made its maiden flight on 26 October, 1940 - after an unusually swift design and production schedule.

The first operational Mustangs were delivered to the Royal Air Force (RAF) in October of 1941 as Mustang Mark-I's. These aircraft saw their initial action in the summer of 1942. Armed with two .50 caliber and four .30 caliber machine guns and limited in high altitude performance, they were used primarily for reconnaissance and 'rhubarb' missions – for zooming in at low altitudes and strafing trains, troops, and enemy installations.

The P-51's were the first American-built fighters to carry the war back across the English channel after the battle of Dunkirk. A short time later they would set another record by being the first single-engine planes of any country to penetrate Germany proper from bases in England. So successful were the powerful little Mustangs that the United States Army Air Forces (USAAF) decided to adopt the aircraft for its own use.

Two improved models were created – a P-51A fighter (designated Mustang Mark-II in the RAF) and an attack version known as the A-36 "Apache". This attack model was equipped with bomb racks and diving brakes and armed with six .50 caliber machine guns. Thus, as the A-36, the Mustang became a triple-threat performer – fighter, strafing, and dive bomber. In these roles, it helped write aerial history in the momentous days when the Allies took Sicily and Italy.



**Figure 1: P-51A Mustang during a test flight near the North American Aviation plant in Inglewood, California, United States, Oct 1942**

Up to this point, the Mustang had been powered by the Allison V-1710 series engine, which did not provide satisfactory high-altitude performance. When the need for higher altitude and longer range fighters developed so urgently, it was decided to see what the Mustang could do to meet these requirements. The Allison engine, with its single-speed supercharger blower, was replaced by the more powerful Rolls-Royce Merlin engine with a 2-speed supercharger blower. Along with other improvements, the prop was increased from three to four blades. Thus was developed the P-51B and C (B if built on the west coast, C if built in Texas – they were essentially the same otherwise), or the Mustang Mark-III as it was known in the RAF.

The new model proved an unquestioned success. The Luftwaffe learned to fear it at any altitude. As for range, the new Mustang made it possible for the first time for fighters to escort heavy bombers all the way from Britain to Berlin. Later, Mustangs escorted bombers all the way to Poland. And when the great triangular shuttle raids connecting England, Russia, and Italy began, P-51's were the first fighters to operate all around the continent-girdling circuit. One of the legs of this triangle was some 1600 miles long!



**Figure 2: P-51B**

The P-51D version of the Mustang retained all of the great features of its predecessor, with important added improvements. Chief among these are the increased visibility for the pilot in a new "bubble" canopy, more convenient cockpit arrangement, and heavier firepower with six .50-cal machine guns fitted in the wings. The 'D' also featured a new dorsal fin to improve directional stability problems encountered when the rear fuselage area of the previous models was reduced to increase rear visibility from the cockpit.



**Figure 3: P-51D**

Becoming the definitive model of the Mustang during World War II, over 8,000 P-51D airframes were produced. As the war drew to a close, P-51s were active not only in the European theatre, but also in the Mediterranean and in the Far East, where, like in Europe, the aircraft's long range and superior performance made it the ideal escort for bombers running missions into the heart of Japan.



**Figure 4: P-51D and P-51B**



# AIRCRAFT OVERVIEW



# AIRCRAFT OVERVIEW

## General Description

The North American Aviation P-51D fighter aircraft is a single-seat, low wing monoplane powered by a 12-cylinder V-1650-7 liquid cooled, Packard built Rolls Royce "Merlin" engine. The engine is equipped with a two-speed, two-stage supercharger and an automatic manifold pressure regulator. The engine spins a four blade Hamilton Standard Hydromatic constant speed propeller.

The Packard engine delivers approximately 1490 horse power at sea level. It has a critical altitude of approximately 14,000 feet in low blower supercharger mode and a critical altitude of approximately 27,000 feet in high blower mode. The maximum altitude is approximately 40,000 feet. The supercharger ratios are approximately 6 to 1 in low blower mode and 8 to 1 in high blower mode.

The fuselage is a semi-monocoque, all-metal structure. The all-metal wings are built in two halves which are joined at the aircraft center line and are of full cantilever structure. The airfoil is of laminar-flow design, which provides low drag even at high speed. The tail section is metal with fabric-covered elevator and rudder control surfaces. The aircraft is flush-riveted throughout – another factor contributing to its great speed.

Two fuel tanks with a total capacity of 184 U.S. gallons are located inside the wing and an additional 85-gallon fuselage fuel tank is located aft of the cockpit.

The armament consists of six .50 caliber machine guns mounted in the wings. Streamlined bomb racks installed beneath each wing panel can accommodate one 100, 300, or 500-lb. bomb each, or a depth charge or chemical tank. The bomb racks can be easily removed. Bombs may be substituted by droppable combat fuel tanks with a capacity of 75 or 110 U.S. gallons each for long-range operations. The wing can also support up to 10 unguided rockets, or up to 6 if bombs are also loaded.

## Specifications

Specifications for the P-51D are:

- Wingspan – 37 feet
- Overall length – 32 feet 3 inches
- Height (tail down) – 12 feet 2 inches
- Prop diameter – 11 feet 2 inches
- Pitch setting – 23° to 65°
- Wing area – 233.19 square feet

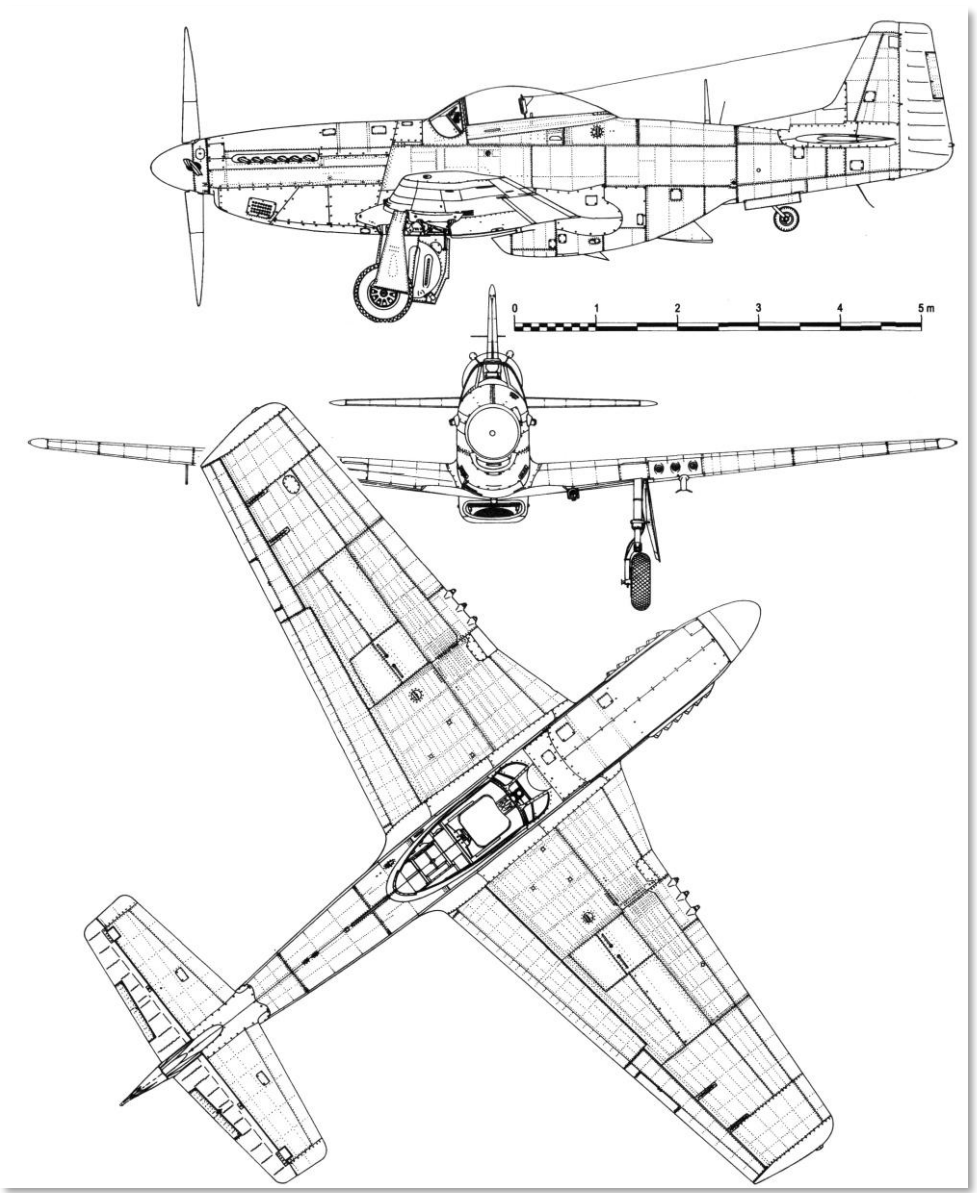
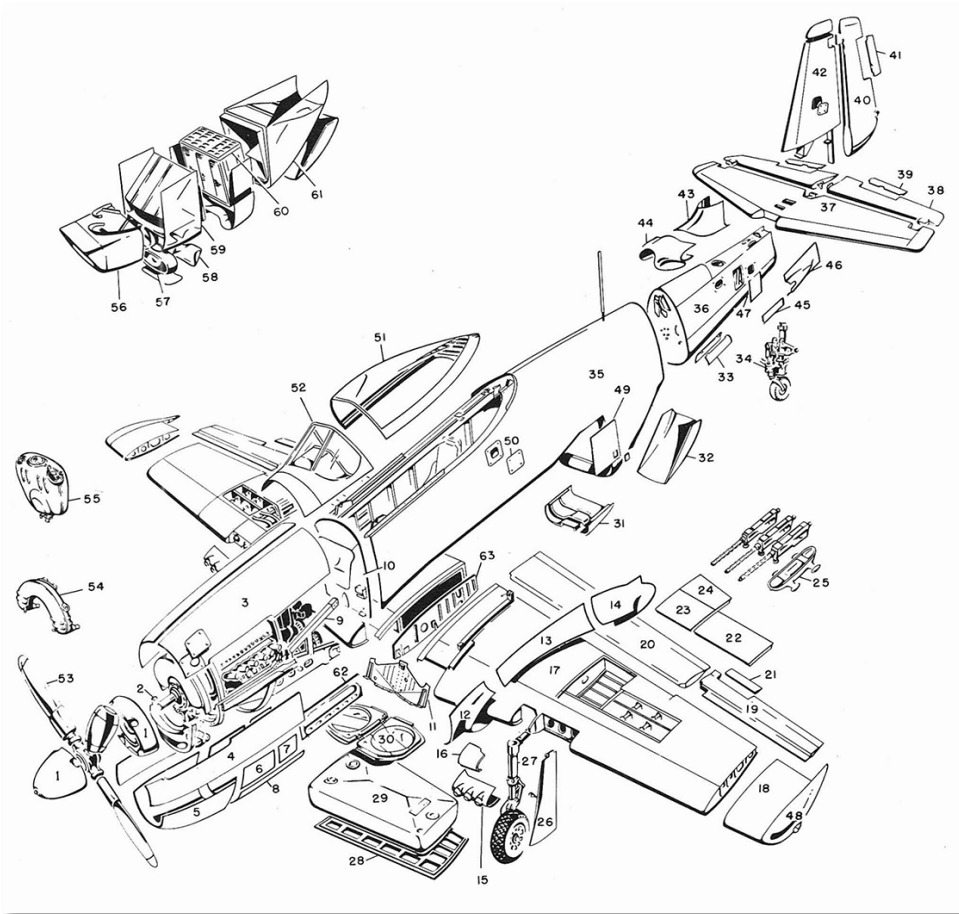

Figure 5: P-51D Drawings

## P-51D Major Assembly Parts



**Figure 6: P-51D Major Assembly Parts**

- |                                  |                                 |
|----------------------------------|---------------------------------|
| 1. Propeller Spinner             | 6. Engine Bottom Cowling Center |
| 2. Engine Mount Front Flare      | 7. Engine Bottom Cowling Rear   |
| 3. Engine Top Cowling            | 8. Engine Bottom Cowling Aft    |
| 4. Engine Intermediate Cowling   | 9. Engine Mount Assembly        |
| 5. Engine Bottom Cowling Forward | 10. Firewall Assembly           |

11. Wing Center Bulkhead
12. Wing Fillet Forward
13. Wing Fillet Intermediate
14. Wing Fillet Rear
15. Gun Nose Assembly
16. Landing Gear Access Door
17. Outer Wing Panel
18. Wing Tip Assembly Inner
19. Aileron Assembly
20. Flap Assembly
21. Aileron Trim Tab Assembly
22. Ammunition Bay Door
23. Gun Bay Door Forward
24. Gun Bay Door Rear
25. Wing Bomb Rack
26. Strut Fairing
27. Landing Gear Strut
28. Fuel Tank Door
29. Fuel Cell
30. Wheel Fairing Door
31. Coolant Radiator Access Cover
32. Radiator Air Scoop Rear
33. Tail Wheel Doors
34. Tail Wheel Assembly
35. Fuselage Assembly Front Covered
36. Fuselage Assembly Rear Covered
37. Horizontal Stabilizer
38. Elevator
39. Elevator Trim Tab
40. Rudder
41. Rudder Trim Tab
42. Fin
43. Fin Fillet Forward
44. Empennage Fillet, Forward
45. Empennage Fillet, Lower
46. Stabilizer Fillet Rear
47. Cover Assembly
48. Wing Tip Assembly Outer
49. Cover Assembly
50. Cover Assembly
51. Canopy
52. Windshield Assembly
53. Propeller Blade
54. Cool. Header Tank Complete
55. Oil Tank
56. Radiator Air Scoop Forward
57. Oil Cooler
58. Oil Cooler Outlet Door
59. Radiator Air Duct Forward
60. Radiator Assembly
61. Air Duct Aft
62. Stack Fairing
63. Rib, Wing Center

## Fuselage

The fuselage is a semi-monocoque, aluminum alloy structure consisting of three sections: engine mount, main fuselage, and aft section. The engine mount is a box-beam structure attached to the firewall at four points and extending forward on each side of and below the engine. The engine mount structure serves as the sole support for all parts of the aircraft which are forward of the firewall. The main fuselage is of the four-longeron type incorporating an A-shaped overturn structure aft of the pilot's seat. Armor plating is provided behind the pilot's seat and is included as part of the firewall. The aft section of the fuselage houses the tail wheel assembly and supports the tail section.

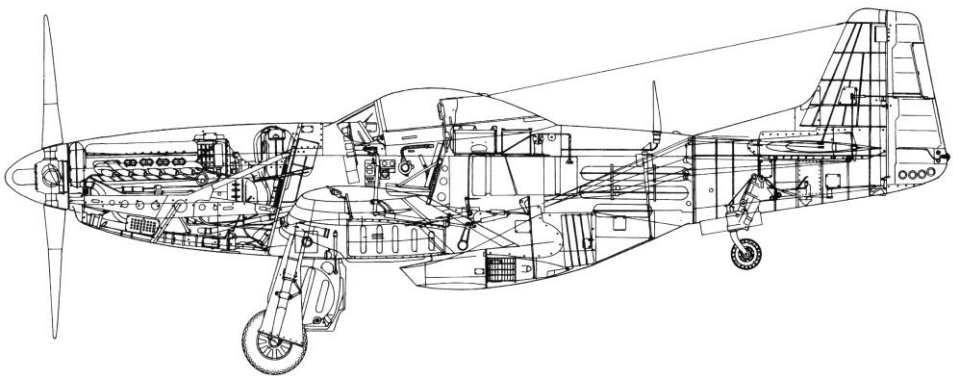

**Figure 7: P-51D Fuselage**

## Canopy

The P-51D features a teardrop canopy design that allows for an unrestricted view around the aircraft. The canopy slides back and forth and is operated by a clutch-and-crank handle on the right side of the cockpit. The canopy is unlocked from the outside by a release button below the canopy on the right side of the fuselage. The forward flat section of the windshield is armor plate glass.

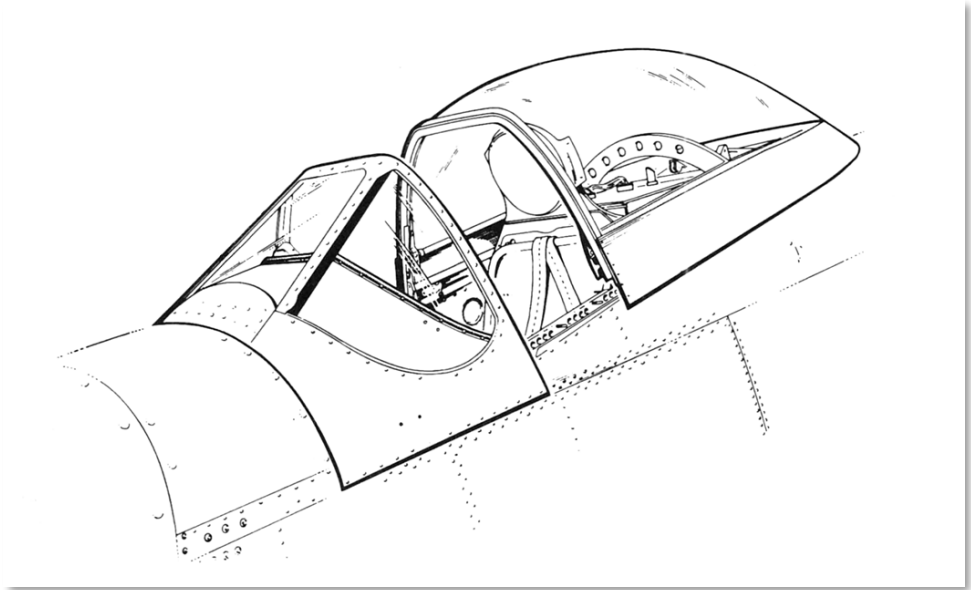

**Figure 8: P-51D Canopy**

## Wing

The airfoil is a full cantilever, two spar, laminar flow wing. It is filler finished and hand polished. The upper and lower leading edge surfaces are covered with a surfer to assure smoothness of the airfoil sections. The metal-covered ailerons are statically, dynamically, and aerodynamically balanced. The left aileron is equipped with a trim tab, controllable from the cockpit. Hydraulically operated, sealed type wing flaps extend from the ailerons to the fuselage.

The efficiency of the wing is adversely affected by nicks, dents, and scratches on the surface.

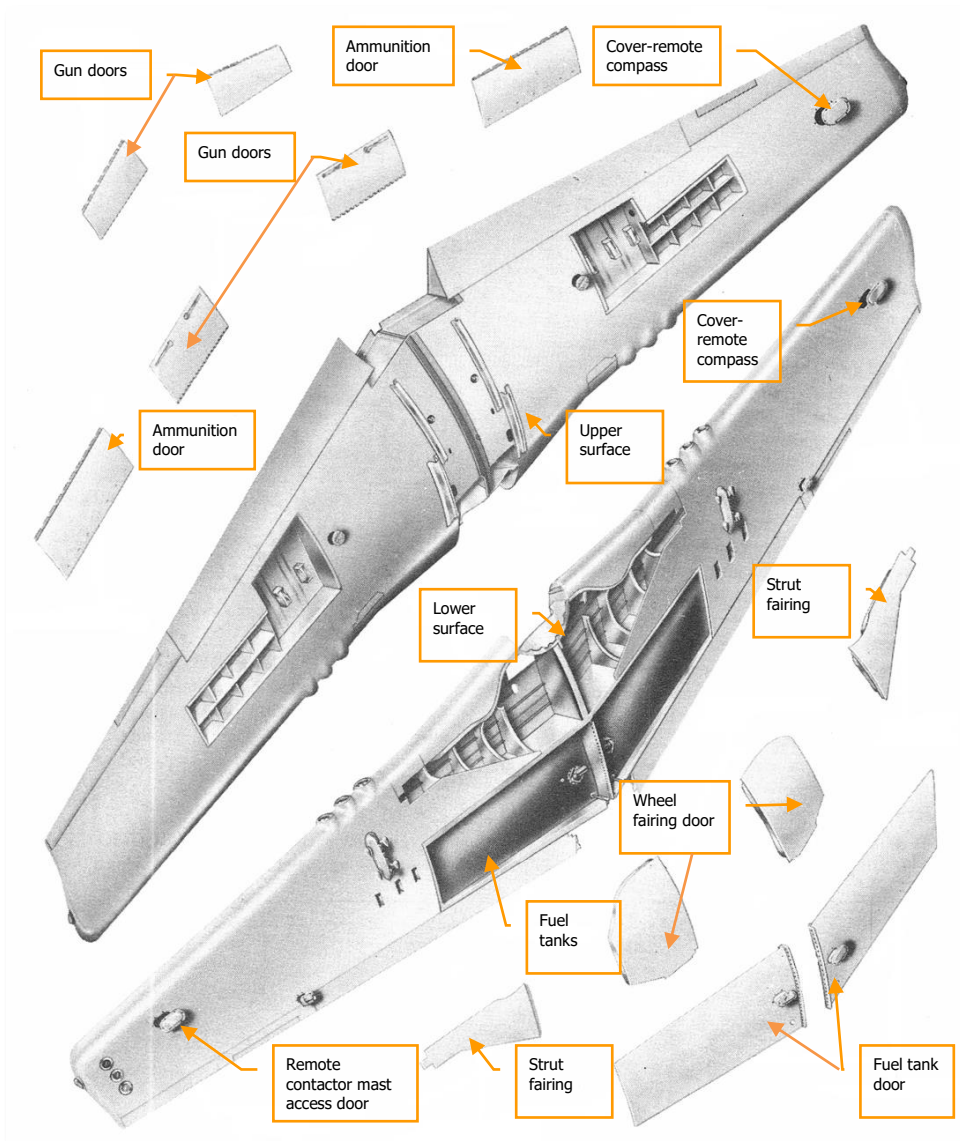

Figure 9: P-51D Wing Covered Assembly



Tests have been conducted at the factory and it was found that, with a strip of wire 1/16" in diameter taped along the leading edge of the wing, the aircraft would not leave the ground. Frost will affect the wing in the same manner; therefore care must be taken to preclude any takeoff attempts with frost on the wing.

Unique to the P-51 in its time was the laminar flow wing, which was developed by the US National Advisory Committee for Aeronautics (NACA). Conventional wing designs feature a cross-section with maximum thickness about a fifth of the way across the wing from the leading edge, with most of the camber on the top of the wing. The laminar flow wing, in contrast, has its maximum thickness well aft from the leading edge, and has almost as much camber on top as on the bottom. This design reduces turbulent flow across the wing, thereby reducing drag and increasing speed and range. Drag was also reduced on the P-51 by positioning a ventral radiator underneath the rear of the fuselage, to present the smallest possible fuselage cross section.

A laminar flow wing of a thin cross section allowed the Mustang to avoid most of the compressibility dive problems that plagued many other high performance fighters of the time.

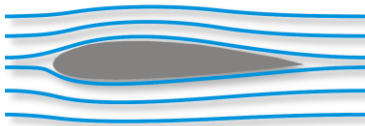

**Conventional Airfoil. Normal Flow.**



**Conventional Airfoil. Compressibility.**

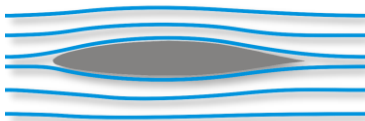

**Laminar Flow Airfoil. Normal Flow.**

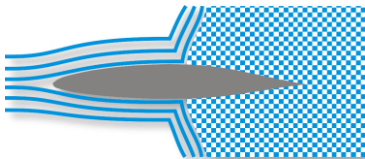

**Laminar Flow Airfoil. Compressibility.**

## Tail Section

The tail section consists of a horizontal stabilizer, vertical stabilizer, elevators, and rudder. The elevators and rudder are equipped with trim tabs controllable from the cockpit. Lead weights are attached to the leading edges to balance the elevators and rudder statically and dynamically.

Compared to the earlier B-C model, the P-51D features a dorsal fin section ahead of the vertical stabilizer for increased lateral control and structural strength.

## Flight Controls

The ailerons, elevators, and rudder are controlled by a conventional stick and rudder pedals. The ailerons are sealed internally so that no air can pass through the opening between the aileron and wing section. This lightens the pressure on the control stick and at the same time provides more positive action.

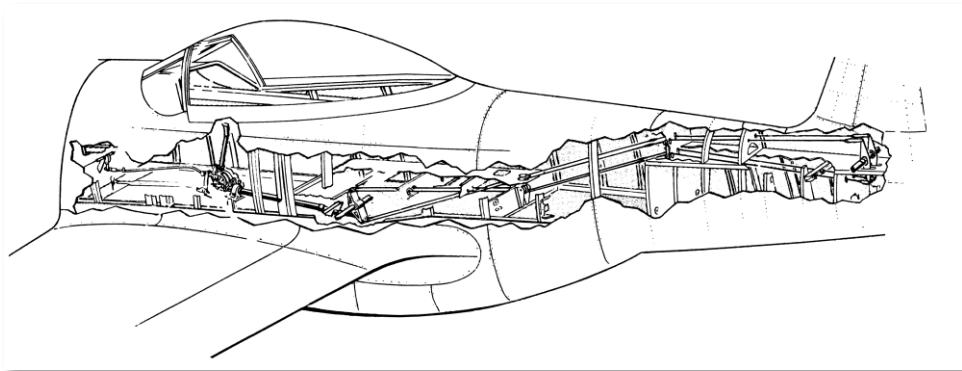

**Figure 10: P-51D Elevator Control System**

The tail section control surfaces are limited to the following angular movements: rudder:  $\pm 30^\circ$ , elevator:  $+30^\circ/-20^\circ$ . The aileron travel can be adjusted to the following settings:  $\pm 10^\circ$ ,  $\pm 12^\circ$ ,  $\pm 15^\circ$ . The flaps extend the full distance from the fuselage to the ailerons and are hydraulically operated by a control handle on the left side of the cockpit. The flaps have a  $47^\circ$  range of movement and are brought to any desired position by moving the control lever to the corresponding angle as indicated on the panel. It takes 11-15 seconds for the flaps to go from the full up to the full down position.

Trim tab controls for the left aileron, rudder, and elevators are also located on the left side of the cockpit. A pointer marker integrated with each control wheel mechanism indicates the position of the tab in degrees. The rudder pedals are adjustable for leg length by means of a lever at the inboard side of each pedal.

## Surface Control Lock

The surface control lock is located at the base of the control stick. To lock the controls, the stick is moved into the locking arm while pulling out the knob on the arm; then the knob is released to lock the stick in place. This locks all of the controls. The rudders catch and are locked when moved into neutral position. To release the lock, the locking arm is pulled out and the spring is moved forward out of the way. Note that there are two holes in the locking lug. When you use the bottom hole, the tail wheel is locked along with the controls. Using the top hole leaves the tail wheel free to swivel 360°, so the aircraft can be towed.



**Figure 11: Surface Control Lock**

## Landing Gear

The landing gear consists of two main gears and a tail gear. All three units are fully retractable hydraulically and are controlled simultaneously by the Landing Gear Control handle on the left side of the cockpit. When the landing gear is retracted, the main gear is completely enclosed in the wings and the tail gear is completely enclosed in the fuselage. The tail wheel is steerable and full swiveling. When the control stick is in the neutral position or pulled back, the tail wheel is locked; in this position it is steerable 6° to the right or left through the use of the rudder pedals. With the control stick positioned forward of neutral, the tail wheel is unlocked for free swiveling action.

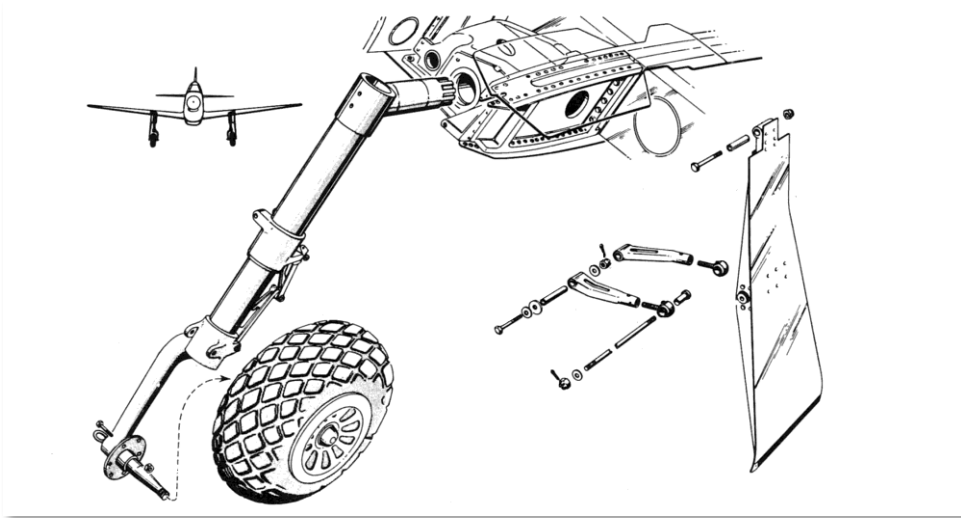

**Figure 12: P-51 Main Landing Gear Housing, Fairing and Shock Strut**

The landing gear takes 10-15 seconds to move into position. In situations where the landing gear must be raised immediately after lowering it, such as go-around, it's important to raise the gear only after it is fully extended and locked. Raising the gear before it locks risks damaging the gear or the fairing doors.

In emergency situations, the landing gear can be released by means of a red handle just above the hydraulic pressure gauge on the front panel of the cockpit. Pulling this handle releases the pressure in the hydraulic lines, allowing the gear to drop of its own weight when the landing gear lever is in the DOWN position. Slight rocking of the aircraft left and right using roll input may be required to ensure the gear is locked in place when hydraulic pressure is released.

Compared to the earlier P-51 B-C models, the landing gear system of the P-51D has been redesigned to save weight. The weight-on-wheels (WOW) safety mechanism on previous models, which prevented the pilot from accidentally retracting the gear while on the ground, has been eliminated. While operating the D model, therefore, attention must be paid not to move the landing gear lever while the aircraft is on the ground.

**When operating the P-51D, do not set the Landing Gear Control handle to the UP position while the aircraft is on the ground!**

The landing light is installed inside the left wheel well and retracts with the gear. An automatic cut-off switch makes it impossible for the landing light to be on when in the retracted position.

## Brake System

The main landing wheel brake system employs hydraulically actuated disc-type brakes. Each brake is operated by individual master brake cylinders located directly forward of the instrument panel. The brakes are selectively controlled by means of toe pedals incorporated into the rudder pedal assembly.

The brake system is entirely separate from the general hydraulic system, however the brake master cylinders receive hydraulic fluid directly from the reservoir of the hydraulic system. A stand-pipe arrangement in the reservoir ensures a reserve of fluid for brake operation even if the supply of fluid for normal hydraulic operation is lost.

A parking brake incorporated into the brake system holds the wheels in a locked condition over long periods of time; the parking brake control handle is just below the center of the instrument panel.

After takeoff, it's important to avoid braking the wheels to stop them from turning. If the brakes are hot from excessive ground use, they are likely to freeze. The design of the gear and the wheel wells is such that under normal conditions the turning of the wheels has no harmful effect even after they have been retracted into the wheel wells.

## Engine

The power plant of the P-51D is a liquid-cooled, 12-cylinder Rolls-Royce Merlin V-1650-7, built in the U.S. by the Packard Motor Car Company. It is equipped with an injection-type carburetor, a two-speed, two-stage supercharger, and develops over 1400 hp on takeoff.

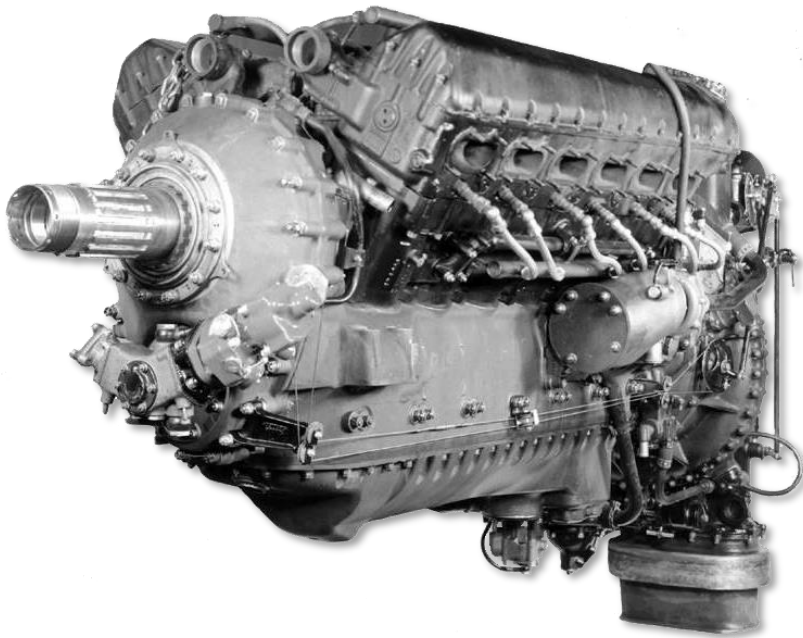

**Figure 13: Packard Merlin V-1650**

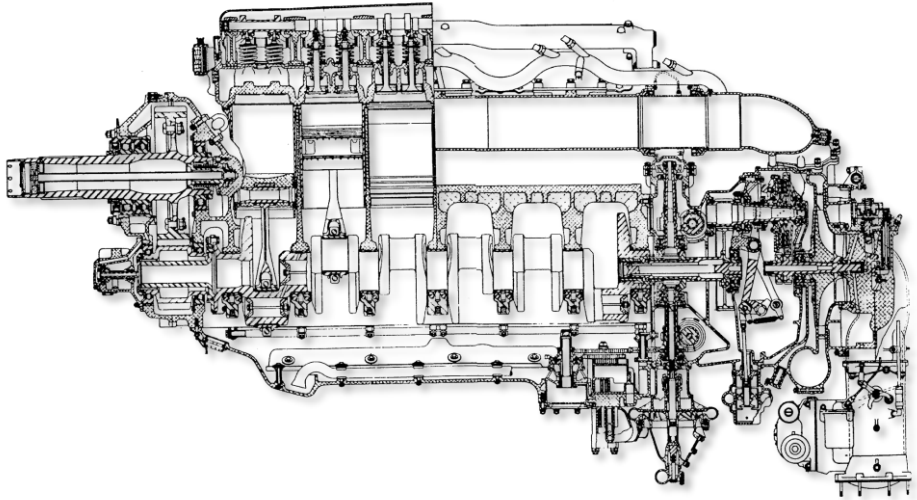

Figure 14: Packard Merlin V-1650

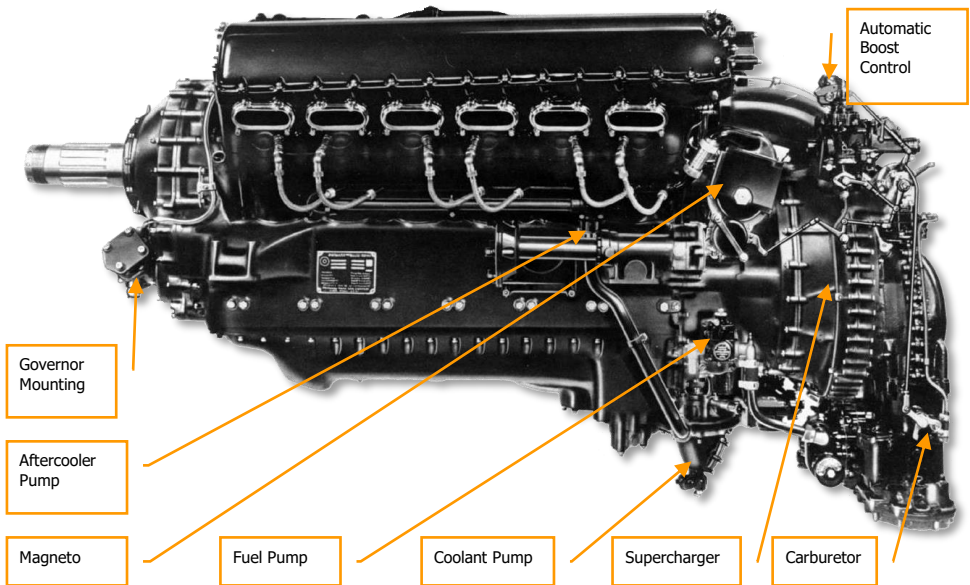

Figure 15: Packard Merlin V-1650

Engine Ratings:									
Operating Condition	RPM	M P	HP	Critical Altitude With Ram	Critical Altitude No Ram	Blower	Mixture Control Position	Fuel Flow (Gal/Hr/Eng.) U.S.	Maximum Duration (Minutes)
Take-Off	3000	61	1400	S.L.	S.L.	Low	Run/ARR	150	5
War Emergency	3000	67	1595 1295	17,000 28,800	11,700 23,200	Low High	Run/ARR Run/ARR	166 160	5
Military	3000	61	1450 1190	19,800 31,200	13,700 25,600	Low High	Run/ARR Run/ARR	158 144	15
Maximum Continuous	2700	46	1120 940	20,500 34,400	17,500 29,500	Low High	Run/ARR Run/ARR	111 106	Cont.
Maximum Cruise	2400 2400	36 35	790 640	19,500 30,200	17,000 28,200	Low High	Run/AL Run/AL	70 70	Cont.

## Supercharger

The supercharger installed on the Packard Merlin engine includes two compressor stages that deliver air from the carburetor intake to the pistons under much greater pressure than would be possible through direct aspiration, allowing a greater fuel-air mixture to be burned and increasing power output.

The supercharger works in either low or high blower mode, selection of which can be automatic or manually set by the pilot. In normal operations, high blower mode starts automatically from 14,500 to 19,500 feet, depending on the amount of ram air being delivered through the carburetor. The supercharger increases the blower-to-engine compression ratio from a low of 5.8 to 1 to a high of 7.35 to 1.

The supercharger can be controlled manually by a switch on the instrument panel. The switch has three positions – AUTOMATIC, LOW, and HIGH.





**Figure 16: Supercharger**

For normal operations, the supercharger switch should be kept in the AUTOMATIC position. In this position, the supercharger is controlled by an aneroid-type pressure switch, which automatically cuts the unit into high or low blower as required. This switch is adjusted to cut the unit back into low blower mode approximately 1,500 feet under the altitude at which it cuts into high blower. This prevents the high blower from going on and off repeatedly with slight changes in altitude near the level at which the high blower cuts in. If the aneroid switch fails, the supercharger automatically returns to low blower.

The LOW position on the switch on the instrument panel makes it possible to operate the supercharger in low blower mode at high altitudes. This provides better range at high altitudes, which can be used for long-range flights.

The HIGH position on the switch makes it possible to test the high blower mode on the ground. The switch must be held in the HIGH position by hand, however, because it is springloaded and returns to the LOW position when released.

An indicator light next to the switch on the instrument panel turns on when the supercharger is in high blower. The light can be pressed to test its functionality.

## Carburetor

The carburetor provides automatic control of the fuel-air mixture passed from the air intake to the supercharger and onto the engine manifold for combustion in the cylinders.

The Packard Merlin engine has an injection-type carburetor and an automatic manifold pressure regulator. The manifold pressure regulator is effective only at pressures in excess of 41 in. The automatic pressure regulator alleviates the pilot from having to jockey the throttle to maintain a constant manifold pressure in the high-speed range during a climb or descent. The pilot is only required to set the desired pressure by setting the throttle lever and the pressure regulator does the

rest. It compensates automatically for the difference in air density at different altitudes by gradually opening the carburetor butterfly valve in a climb or smoothly closing it in a descent.

Carburetor air comes through a long carburetor air scoop directly under the engine. The aircraft's motion forces air at high speed (or rams it) directly into the carburetor. This is termed ram air.

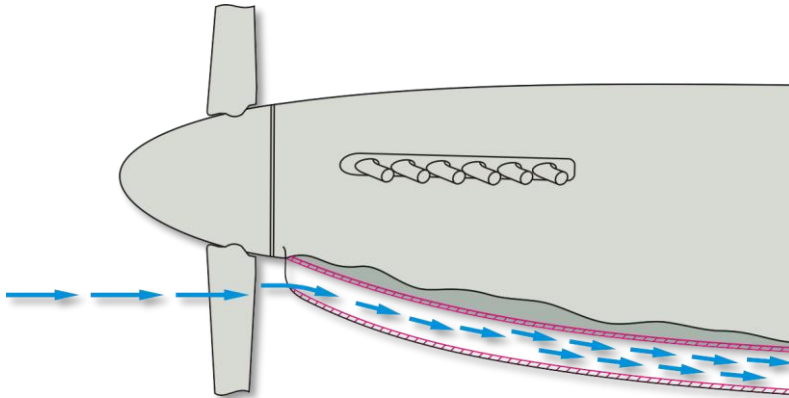

**Figure 17: Ramming Effect**

If the scoop becomes obstructed by ice or other foreign matter, a door in the air duct opens automatically to admit hot air from the engine compartment to the carburetor.

During normal operations, ram air is always used, but in the event of extreme icing or dust conditions, the carburetor air controls on the left cockpit pedestal allow the pilot to select either unrammed filtered or, in later model aircraft, unrammed hot air for operation. In order to obtain hot air, the Hot Air control handle must be set to HOT and the Cold Air control handle set to UNRAMMED FILTERED AIR. If the Cold Air control handle is set to RAM AIR, the hot air control will be ineffective.

Hot air should not be used above 12,000 feet. At high altitudes its use affects the carburetor's altitude compensation and may result in an overly lean fuel mixture.

## War Emergency Power

In order to provide an extra boost to the engine in extreme situations, the throttle can be moved past the gate stop by the quadrant to break the safety wire. The engine will then be opened up to its absolute limit and will give approximately 6 in. of additional manifold pressure in excess of the normal full throttle setting of 61 in. (with mixture control set to RUN or AUTO RICH and prop set for 3000 RPM.) This throttle reserve is called War Emergency Power (WEP) and should be used only in extreme situations. If used for more than 5 minutes at a time, vital parts of the engine may be damaged.

WEP provides no benefit at altitudes below 5,000 feet. The throttle alone provides more than enough power to exceed the operating limits of the engine at these altitudes.

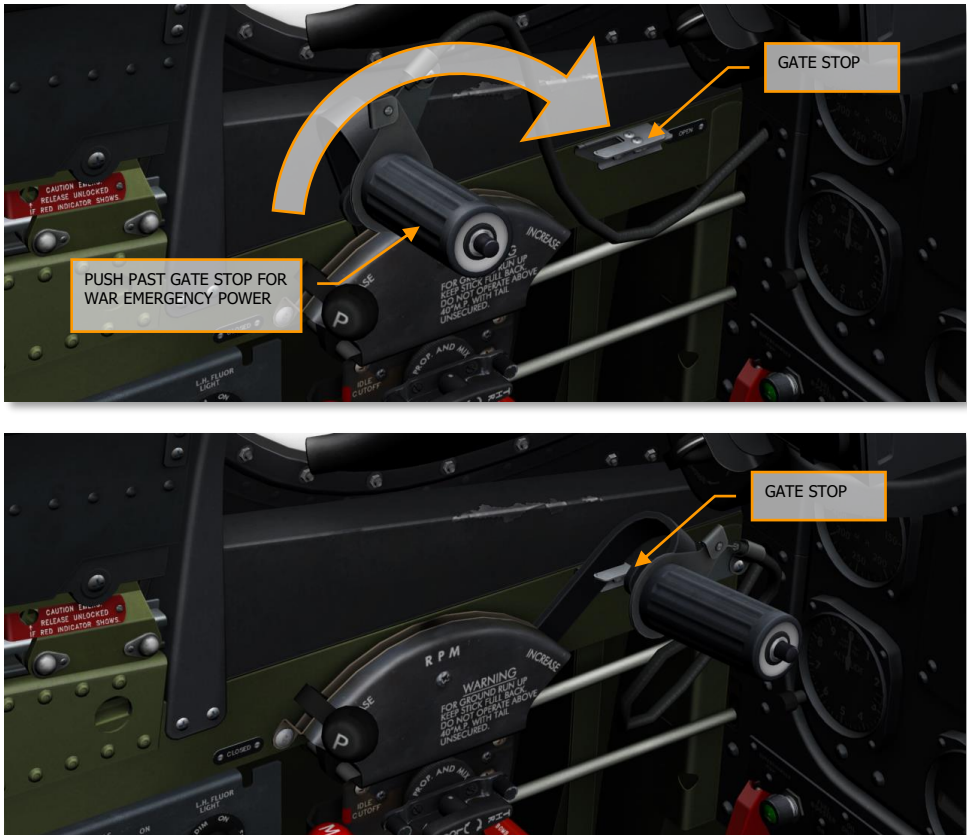

Figure 18: War Emergency Power

## Propeller

The P-51D propeller is a Hamilton Standard four-blade, hydraulic, constant-speed propeller with a diameter of 11 ft, 2 in and a blade pitch range of 42°, set to 23° at low pitch and 65° at high pitch. The propeller RPM is controlled by the Propeller Control lever on the throttle quadrant in the cockpit. The propeller governor automatically controls propeller pitch to maintain a constant speed between 1800 and 3000 RPM, depending on the Propeller Control setting. The propeller cannot be feathered.

## Fuel System

The Mustang features two main fuel tanks, one in each wing. The main tanks have a capacity of 92 gallons in each or a total of 184 gallons. An auxiliary 85 gallon tank is installed in the fuselage aft of the cockpit. There is also provision for carrying two droppable combat tanks on the wing bomb racks. These are available in 75-gallon and 110-gallon capacities. The total fuel capacity of the aircraft, including two 110-gallon droppable tanks, is 489 U.S. gallons.



**Figure 19: Fuel Selector Valve**

The fuel tanks are self-sealing and so are the fuel lines. The auxiliary drop tanks are not self-sealing. Fuel is forced to the carburetor by an engine-driven pump at a normal operating pressure of 16-19 PSI. In addition, there is an electrically powered booster pump in each internal tank. The booster pumps prevent vapor lock at high altitudes, assure sufficient fuel supply under all flight conditions and, in case of engine-driven pump failure, provide enough fuel to the carburetor for normal engine operation. The droppable tanks do not have a booster pump. However, a constant and controlled pressure of 5 lbs./sq.in. is maintained within the combat tanks by pressure obtained from a vacuum pump. This is in addition to the pressure obtained from the main engine fuel pump.

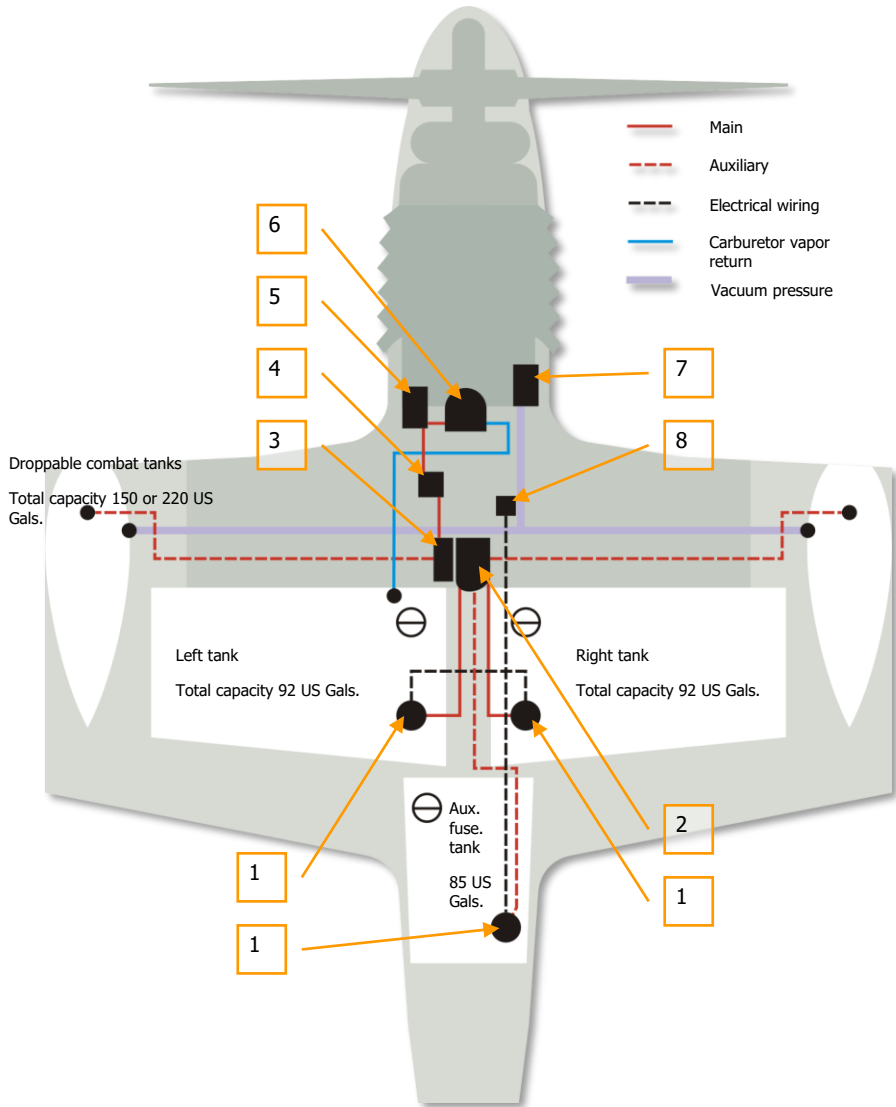

**Figure 20: P-51 Fuel System**

- 1. Booster Pump
- 2. Fuel Selector Valve

3. Fuel Shut-Off Valve
4. Fuel Strainer
5. Engine-Driven Pump
6. Carburetor
7. Vacuum Pump
8. Booster Pump Switch

The tanks are not interconnected and it is necessary to switch from one tank to the other to maintain balance. The three booster pumps are controlled by a single switch on the front switch panel. Selection between the tanks is performed by turning the booster pump switch to ON, then turning the fuel selector valve to the desired tank.

Fuel capacity is monitored using the [Fuel Gauges](#) for the main and fuselage tanks. No gauges for drop tanks are available.

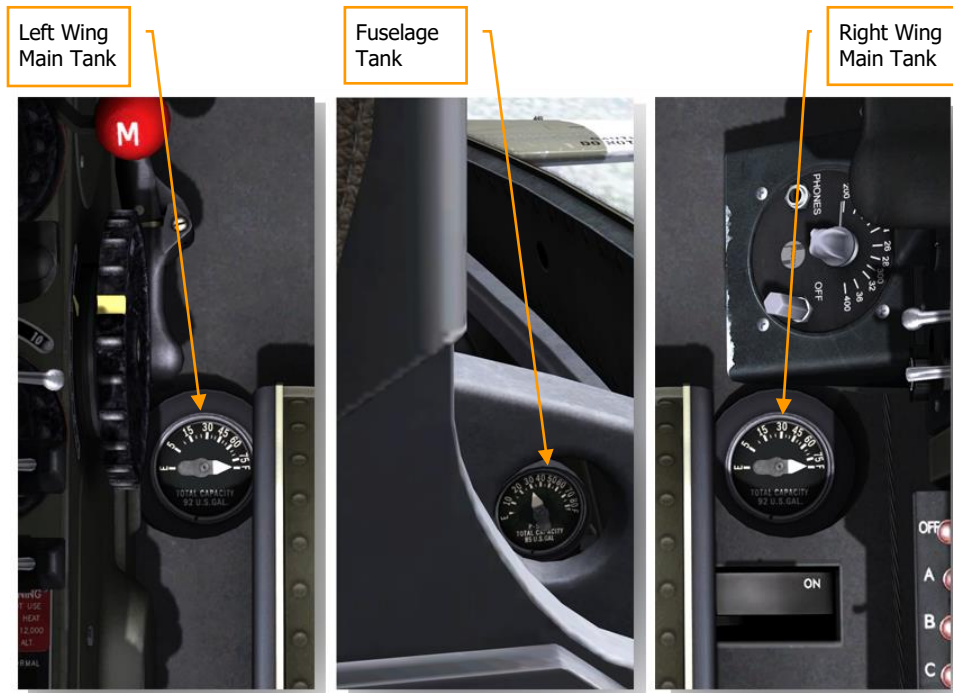

Figure 21: Fuel Gauges

The carburetor is of the fuel injection type with a separate idle cut-off device and is equipped with a vapor return line that extends to the left fuel tank. The vapor vent line may become a fuel return line if the needle valve in the vapor eliminator sticks in the open position. The left fuel tank should always be used first to ensure availability of space for any returning fuel.

**When changing tanks, don't stop the selector valve at an empty tank position, or at a droppable tank position if no droppable tanks are equipped. Starving the engine of fuel will result in engine failure. In such a case, perform the following steps immediately:**

- 1. Turn the fuel selector to a loaded tank;**
- 2. Make sure that the booster pump switch is ON;**
- 3. As the engine takes hold, adjust the throttle setting as required.**

## Hydraulic System

The P-51D is equipped with two separate hydraulic systems. One is the main power system for the operation of the landing gear and wing flaps. The other system is the foot pedal-operated brake system. The only connection between the two systems is that they receive their supply of fluid from the same reservoir in which a 3 cubic in. capacity cup is arranged so that in the event all the hydraulic fluid from the main power system might be lost, the brakes may still be operated.

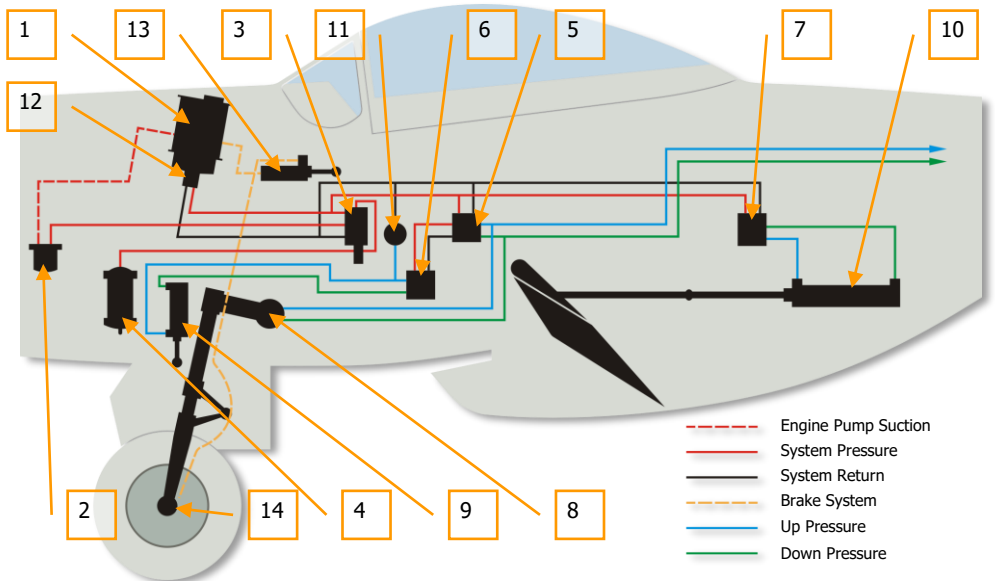

**Figure 22: Hydraulic System**

1. Reservoir

2. Engine-driven Pump
3. Unloading and Relief Valve
4. Pressure Accumulator
5. Landing Gear Control Valve
6. Fairing Door Control Valve
7. Wing Flap Control Valve
8. Landing Gear Operating Strut
9. Fairing Door Operating Strut
10. Wing Flap Operating Strut
11. Emergency Release Valve
12. Check Valves
13. Master Brake Cylinders
14. Disc-type Brake

In the main power system, a pump is permanently geared to the engine and maintains a pressure of 800-1100 lbs/sq.in. As long as the engine is running, the engine unloading valve loads the hydraulic system when hydraulic pressure drops to 800-850 lbs. It unloads the system when hydraulic pressure reaches 1050-1100 lbs. In the event of hydraulic pump failure, no provision is made for emergency operation of the wing flaps.

Incorporated into the hydraulic system on all P-51 model aircraft is a [Landing Gear Fairing Door Emergency Release handle](#). The purpose of this handle when pulled out is to release or bypass hydraulic pressure from the fairing door cylinders and lines back directly to the reservoir. After the knob has been pulled out and has served its purpose, pushing it back in will once again restore normal operation of the hydraulic system. Therefore, if emergency landing gear procedure has been followed, push the knob back to attempt normal operation of the flaps. If flaps fail to extend, no emergency procedure is available.

## Oil System

The oil system includes a tank just forward of the firewall and a radiator in the air scoop under the fuselage. The full capacity of the oil system is 21 U.S gallons. The tank is a hopper type - that is, it is designed with hoppers or compartments which facilitate quick warm-up and also make it possible to fly the aircraft in adverse attitudes or with little oil in the system.

With this tank, the P-51 can be flown in any attitude when the tank is full. The aircraft can also be put into a vertical climb or dive when the tank is only 1/4 full and it will continue to provide proper lubrication. However, when the aircraft is in inverted flight, the oil pressure falls off, because no oil reaches the scavenger pump. For this reason, inverted flight must be limited to 10 seconds.



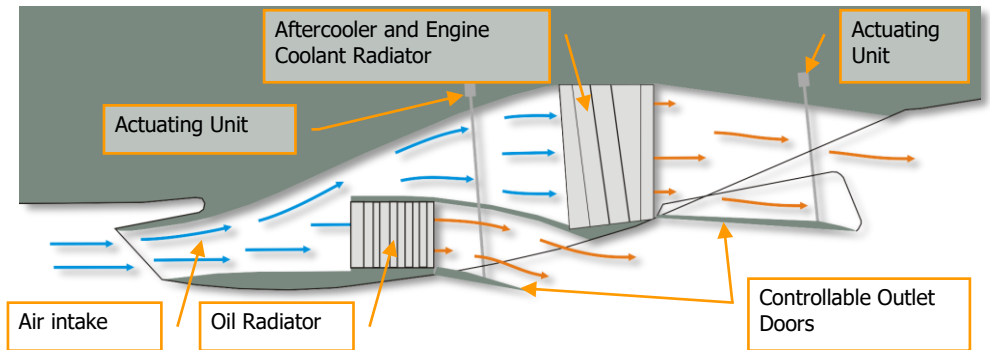

**Figure 23: P-51D Radiators**

An outlet door on the bottom of the air scoop controls the oil temperature. Under ordinary conditions this door is operated automatically. However, it can be operated manually when running the engine on the ground or in case the automatic regulator fails in the air. This can be done by means of the Oil Radiator Air Control switch, located on the [Radiator Air Control panel](#) on the left side of the cockpit. The switch has three positions: AUTOMATIC, OPEN, and CLOSE. The door can be set in any position by holding the toggle switch in the OPEN or CLOSE position for the necessary length of time (approximately 20 seconds), then returning the switch to neutral.

The oil system uses standard Air Force oil dilution equipment. This allows the oil to be thinned with gasoline to make the engine easier to start in ambient temperatures below 40°F. Thinning the oil requires allowing the engine to idle with the coolant flap open until the oil temperature drops to 50°C or less. Then, before stopping the engine, oil is diluted using the Dilution switch on the Engine Control panel of the front dash. This will dilute the oil until the engine is ready to be started again. Once the engine warms up, the gasoline in the oil is quickly evaporated.



**Figure 24: Oil Dilution Switch**

If the engine temperature is high, the engine should be stopped to allow it to cool to an oil temperature of about 40°C. Then the engine can be started again. The oil should be diluted immediately as explained above.

Two minutes of oil dilution is sufficient for any ambient temperature down to 10°F. When starting in temperatures lower than 10°F, heating the engine and oil may be necessary. Dilution duration will vary in such cases depending on local conditions.

**Specifications for the oil system include:**

	Temperature [°C]	Pressure [lbs/sq.in.]
Minimum	<b>40</b>	<b>60</b>
Desired	<b>70 - 80</b>	<b>70 - 80</b>
Maximum	<b>90</b>	<b>90</b>

## Coolant System

With the radiators located in the big air scoop aft of the cockpit under the fuselage, the cooling of the P-51 engine is quite different from that of most other fighters of the era. The engine is cooled by liquid in two separate cooling systems. The first system cools the engine proper, the second (called the after-cooling system) cools the supercharger fuel-air mixture. Each performs a separate function

and the systems are not connected in any way. They both pass through a single large radiator, but in different compartments.

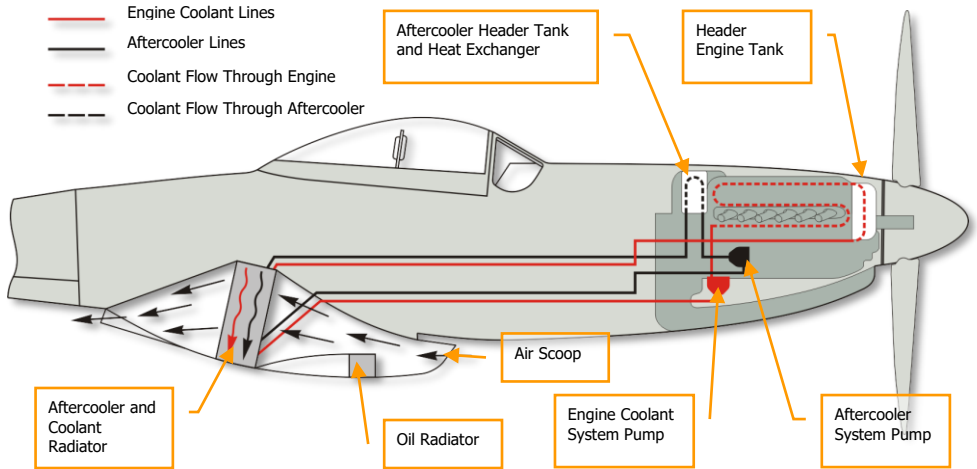

**Figure 25: Coolant System Flow**

The engine coolant system is a high-pressure system (30 PSI) and its capacity is 16 1/2 U.S. gallons. Operating pressure of the after-cooling system is lower (20 PSI) and its capacity is 5 U.S. gallons.

The coolant used is a mixture of ethylene glycol and water, treated with a corrosion preventative. There are two types - Type D for normal use, which consists of 30% glycol and 70% water, and Type C for winter use (below 10°F), which consists of 70% glycol and 30% water.

An air outlet door at the rear of the air scoop controls the temperature of the coolant. This door operates similarly to that of the oil cooler. Normally, it works automatically, but can be controlled manually by means of the Coolant Radiator Air Control switch on the [Radiator Air Control panel](#) on the left side of the cockpit.

**Specifications for the coolant system include:**

	Temperature [°C]
Minimum	<b>60</b>
Desired	<b>100 - 110</b>
Maximum	<b>121</b>

## Electrical System

The electrical system is a 24-volt, direct-current (DC) system which provides power for operating the various aircraft systems, controls, and lighting equipment. The system employs the aircraft's metallic structure as a common ground return.

The electrical system runs off the battery until the engine reaches 1500-1700 RPM, when the generator is cut in by the voltage regulator. The battery charge and power for the electrical system is then supplied by the generator. An external battery receptacle is mounted on the right side of the fuselage at the trailing edge flap.



**Figure 26: Electrical Control Panel**

To prevent any damage to the electrical system from overload, circuit breakers are used. These eliminate the use of fuses and allow for the possibility of replacing broken circuits in mid-flight.

The circuit breaker reset buttons are on the [Electrical Control panel](#). All of the buttons can be reset at once by means of a vertical "bump" plate that covers all of the switches. The ammeter gauge is also located on the Electrical Control panel. The ammeter indicates how much current is flowing from the generator and also shows whether or not the generator has cut in at 1500-1700 RPM as it should.

The battery is just behind the pilot's armor plate in the radio compartment. The battery and generator disconnect switches are located on the Electrical Control panel. The generator switch should be left on at all times when the engine is running. The maximum normal charging rate of the generator is 100 amperes.

**The ammeter should be checked prior to takeoff. Takeoff should not be attempted if the generator is charging over 50 amperes.**

The electrical system controls the emergency fuel pumps, remote compass, pitot heater, gun heaters, gunsight, radios, carburetor air temperature gauge, coolant temperature gauge, bomb release, warning lights, circuit breakers, oil dilution system, and IFF destructor controls. The lights controlled by the electrical system include cockpit lights, the landing light in the left wheel well, recognition lights installed on the underside of the right wing, and standard navigation lights on the wingtips and rudder.

Except for the booster coil, which is used only in starting, the ignition system is completely independent of the electrical system and will continue to function normally in case of electrical system failure. Ignition power is supplied by the magnetos, the switch for which is on the front switch panel. The P-51D starter can easily overheat due to the large loads. The starter should not be used for more than four 20-second attempts to start, with 15-second intervals, followed by a 5-minute cooling period.

## Oxygen System

The oxygen system of the P-51D is a low-pressure, demand-type system. A regulator automatically provides the correct amount of oxygen required at any altitude. Controls and gauges for the oxygen system are located in the right front section of the cockpit and include an automatic mixture regulator, a pressure gauge, and a blinker indicator which opens when the pilot inhales and closes when the pilot exhales.

The oxygen supply is carried in four tanks installed just aft of the fuselage fuel tank. Two D-2 and two F-2 tanks are supplied for a total capacity of 3000 cubic in. Normal full pressure of the system is 400 PSI.

**Oxygen is flammable! Take every precaution to keep oil, grease, and all such readily combustible materials well away from any oxygen equipment, including the breathing mask.**

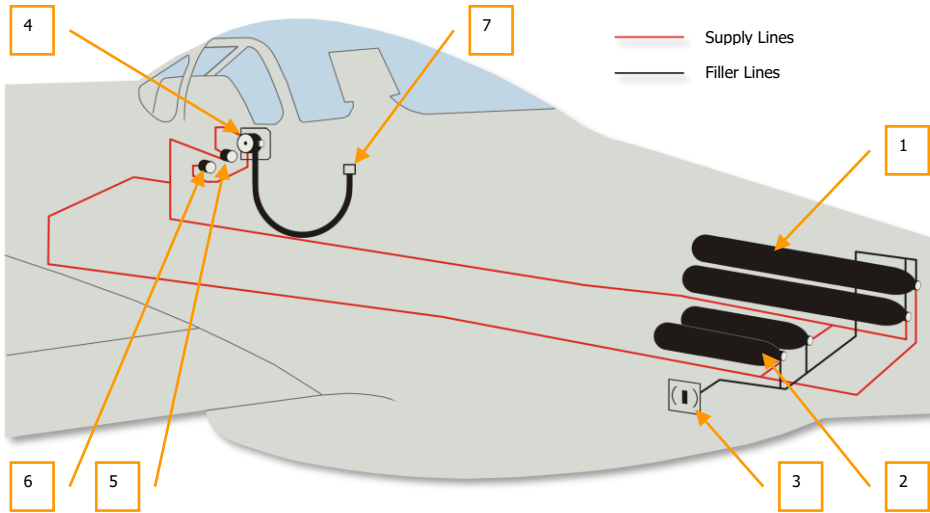

**Figure 27: Oxygen System**

1. Low Pressure Oxygen Cylinder Type F2
2. Low Pressure Oxygen Cylinder Type D2
3. Filler Valve
4. Oxygen Regulator
5. Pressure Gauge
6. Blinker Flow Indicator
7. Oxygen Mask Tube

## Approximate Oxygen Supply

Oxygen consumption depends on many varying factors, so the following is only an approximate time of available supply. These times are based on a 400 PSI initial pressure in the system.

Altitude [ft]	Normal Oxygen	100% Oxygen	Emergency
40,000	11.4 Hrs.	11.4 Hrs.	12.6 Min.
35,000	8.1	8.1	12.6
30,000	6.0	6.0	12.6

<b>25,000</b>	6.0	4.9	12.6
<b>20,000</b>	7.1	3.3	9.0
<b>15,000</b>	8.1	2.7	9.0
<b>10,000</b>	10.2	2.1	9.0

As an aircraft ascends to high altitudes where the temperature is normally quite low, the oxygen cylinders become chilled. As the cylinders become colder, the oxygen gauge pressure is reduced, sometimes rather rapidly. With a 100°F decrease in temperature in the cylinders, the gauge pressure can be expected to drop by 20%. This rapid fall in pressure is not a cause for alarm. All of the oxygen remain in place and as the aircraft descends to lower altitude, the pressure will tend to rise again. A rapid fall in oxygen pressure while the aircraft is in level flight or while it is descending, is not normal and should be considered an indication of a leakage or loss of oxygen.

Hypoxia (ill effects from oxygen starvation) may not begin immediately after normal air stops being supplied to the pilot. The onset of hypoxia effects may be delayed by as much as half an hour or more to just a few seconds, depending largely on altitude and other factors. The table below illustrates approximate Time of Useful Consciousness (TUC) after normal oxygen flow is stopped.

<b>Altitude [ft]</b>	<b>TUC</b>
<b>15,000</b>	30 min or more
<b>18,000</b>	20-30 minutes
<b>22,000</b>	5-10 minutes
<b>25,000</b>	3-5 minutes
<b>28,000</b>	2.5-3 minutes
<b>30,000</b>	1-3 minutes
<b>35,000</b>	30-60 seconds
<b>40,000</b>	15-20 seconds
<b>45,000</b>	9-15 seconds
<b>50,000</b>	6-9 seconds

## Environmental Systems

Warm air for heating the cockpit and for defrosting the windshield is conducted from a port in the dome aft of the coolant radiator through a flexible duct to a point behind the pilot's seat. The air then passes to the cockpit hot air outlet valve at the right side in front of the pilot's seat. From the

defroster valve, warm air is conducted to a distributor fitting, to which windshield defroster tubes are attached. The two valves are of the gate type. A pointer attached to the valve handle indicates the position of the gate.

Air for cooling and venting the cockpit is diverted by a scoop above the forward part of the radiator scoop and conducted through a flexible tube to a valve behind the pilot's seat. Two smaller flexible tubes attached to the valve conduct the cool air to the outlets located behind and on each side of the pilot's seat just below the canopy line. The valve is controlled by a handle on the floor in front of the right side of the pilot's seat.

## Radio Equipment

The radio equipment of the P-51D consists of a SCR-522 VHF (Very High Frequency) radio for voice communication and radio homing, a Detrola LF (Low Frequency) radio receiver, an AN/APS-13 rear-warning radar, and an SCR-695A IFF (Identification Friend or Foe) radio.

All radio equipment is stored in the fuselage aft of the cockpit. Controls are grouped on the right side of the cockpit. Each set has a dedicated antenna arrangement: the VHF antenna mast extends vertically above the fuselage aft of the cockpit, the Detrola wire antenna runs from the back armor plate to the top of the fin, the AN/APS-13 antenna rods extend horizontally from the sides of the fin, and the IFF antennae project from the undersides of the wings.

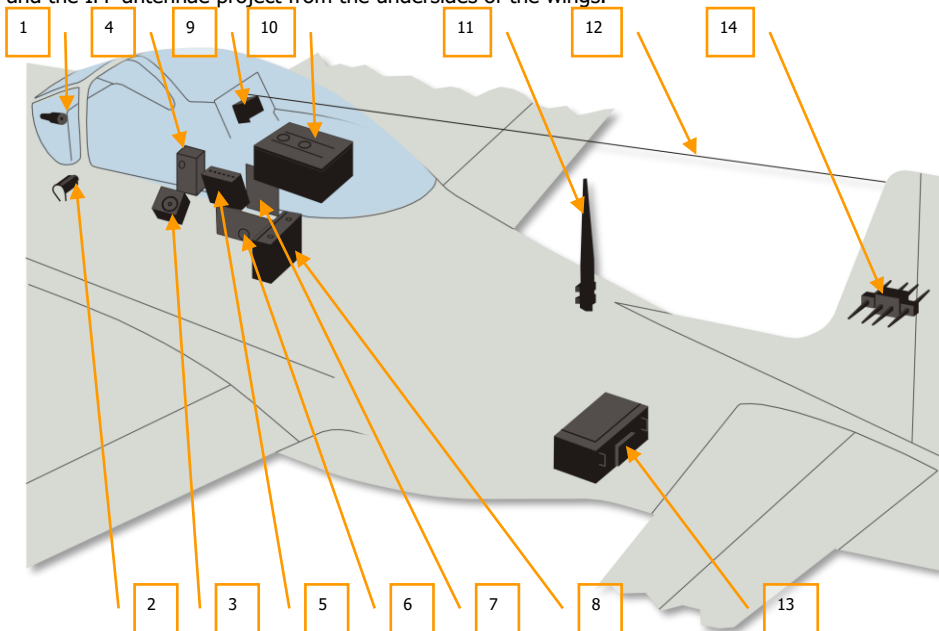

**Figure 28: Radio Equipment**



1. AN/APS-13 Signal Light
2. Microphone Button
3. Detrola Radio Set
4. AN/APS-13 Control Panel
5. SCR-522-A Control Panel
6. AN/APS-13 Signal Bell
7. IFF Control Panel
8. SCR-522-A Dynamotor
9. Antenna Relay Box
10. SCR-522-A Radio Set
11. SCR-522-A Radio Mast
12. Detrola Antenna
13. AN/APS-13 Radio Set
14. AN/APS-13 Antenna

## Armor

Armor plating is provided at three points: back of the pilot's seat, at the firewall in the opening between the engine and the fuselage, and behind the spinner, in front of the coolant tank. Further, protection is provided by the bulletproof glass windshield and the engine itself, which protects the pilot from head-on fire.

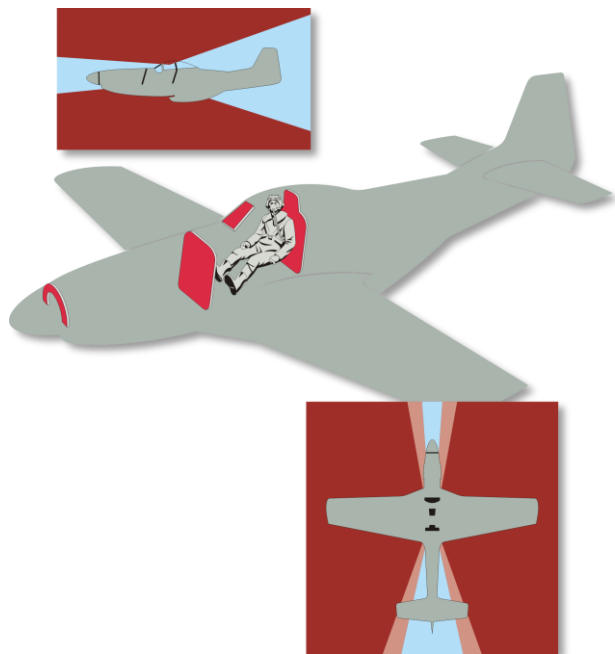

**Figure 29: P-51D Armor**

## Armament

The P-51D is equipped with six free-firing .50 caliber machine guns, three in each wing. The guns are manually charged on the ground and fire simultaneously when the Gun Trigger switch is pressed on the front of the control stick grip. The maximum ammunition capacity is 400 rounds for each of the inboard guns and 270 rounds for the center and outboard guns for a total ammunition load of 1880 rounds. The guns can be adjusted on the ground for different convergence points based on the tactical needs of the mission. Normally the convergence point is set to 250 - 300 yards. The amount of ammunition remaining is not indicated in the cockpit.

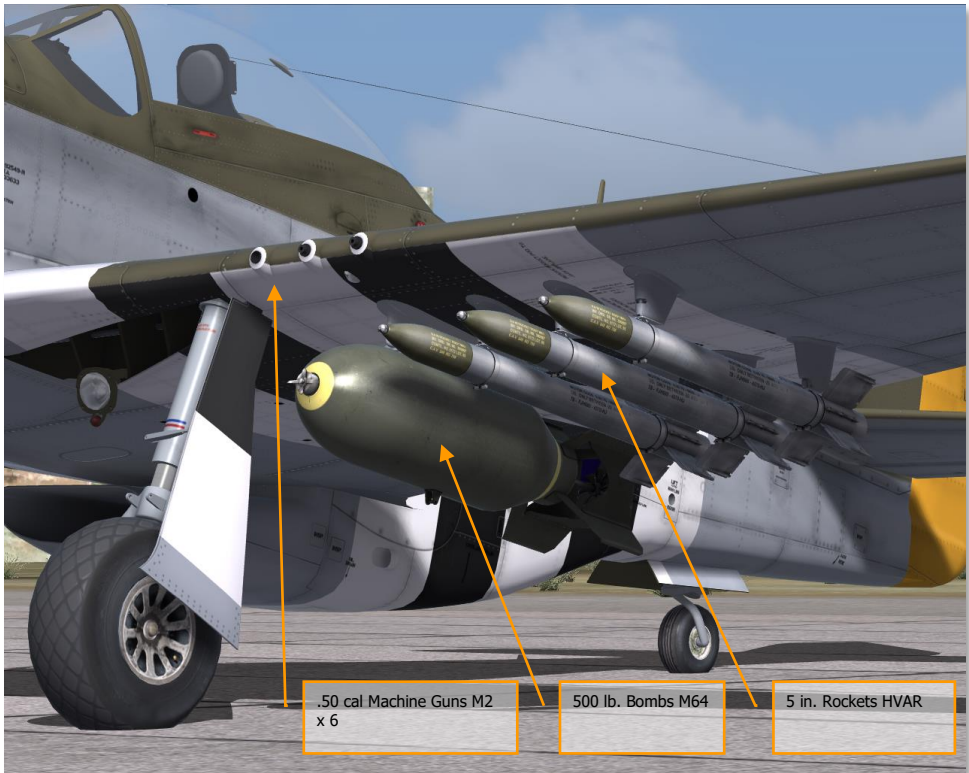

**Figure 30: P-51D Armament**

If the mission needs require longer firing time, it's possible to remove the center gun in each wing. This allows each outboard gun to be loaded with 500 rounds.

A single removable bomb rack can be attached to each wing. These can be loaded with either 100, 250, or 500 pound bombs. If bombs are not installed, chemical smoke tanks or droppable fuel tanks may be hung on the bomb racks. Bombs are released by pressing the Bomb-Rocket Release switch on top of the control stick grip.

In addition to the machine guns and bombs, up to ten 5 in. rockets, five under each wing, can be equipped to perform ground attack missions. When bombs or droppable tanks are carried, only six rockets can be loaded, three on each wing. The rockets are fired by pressing the Bomb-Rocket Release switch on top of the control stick grip.



**Figure 31: Control Stick**

The aircraft is equipped with a K-14 gunsight, mounted on the instrument hood centerline. The sight includes both fixed and gyro-actuated optical systems, and computes the correct lead angle for targets at ranges from 200 to 800 yards. The K-14A sight features range lines on the fixed reticle, used for aiming rockets.

The P-51D is equipped with a gun camera, installed on the leading edge of the left wing.

# COCKPIT



## COCKPIT

The cockpit instruments and controls of the P-51D are grouped to provide the greatest possible efficiency in the limited space available. The cockpit can be both heated and ventilated. The pilot's seat is designed to accommodate either a seat-type or a back-pack parachute. The back cushion is kapok-filled and can be used as a life preserver. The seat is adjustable vertically, but not forward-aft. A small, folding arm rest is provided on the left side of the cockpit for increased comfort during long flights. A standard safety belt and shoulder harness is provided. A lever on the left side of the seat allows the pilot to relax the harness tension to allow for leaning forward.

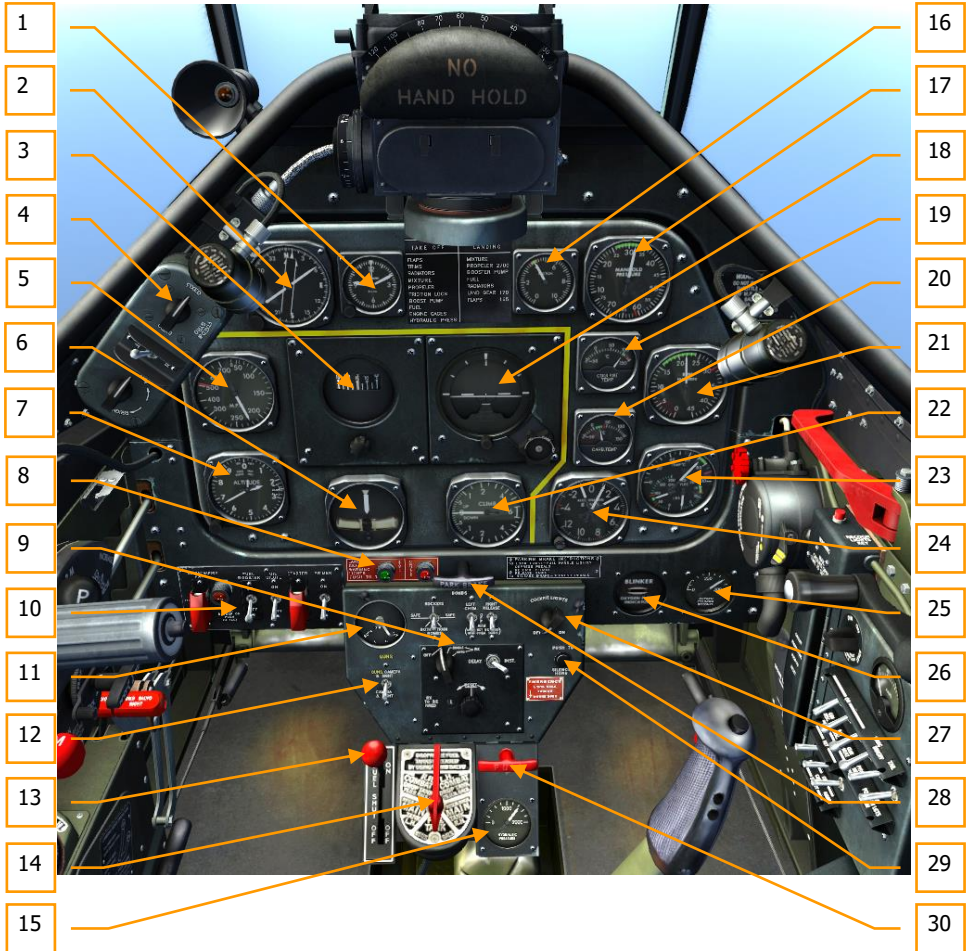

**Figure 32: P-51D Cockpit**

The cockpit is divided into three primary areas: the front dash, which includes the K-14 gunsight, the instrument panel, and the front switch panel, the right side with canopy controls, oxygen system controls, the Electrical Control panel, and radio systems controls, and the left side with engine, trim, and additional controls.

## Front Dash Legend

The front dash of the P-51D cockpit houses the K-14 gunsight along with its associated controls, the instrument panel, engine control panel, landing gear warning lights, front switch panel, fuel system valve switches, and a number of additional indicators and controls.



**Figure 33: P-51D Cockpit Front Dash**

- |                            |                                   |
|----------------------------|-----------------------------------|
| 1. Clock                   | 3. Directional Gyro               |
| 2. Radio Indicator Compass | 4. Gunsight Selector-Dimmer Panel |

5. Airspeed Indicator
6. Bank and Turn Indicator
7. Altimeter
8. Landing Gear Warning Lights
9. External Stores Control Switches
10. Engine Control Panel
11. Ignition Switch
12. Gun, Camera and Sight Switch
13. Fuel Shut-Off Valve
14. Fuel Selector Valve
15. Hydraulic Pressure Gauge
16. Suction Gauge
17. Manifold Pressure Gauge
18. Flight Indicator
19. Coolant Temperature
20. Carburetor Air Temperature
21. Tachometer
22. Rate of Climb Indicator
23. Oil Temperature, Fuel, and Oil Pressure Gauge
24. Accelerometer
25. Oxygen Pressure Gauge
26. Oxygen Flow Indicator
27. Cockpit Light Control
28. Parking Brake Handle
29. Horn Silence Button
30. Landing Gear Fairing Door Emergency Release Handle



## Left Side Legend

The left side of the cockpit includes the primary engine and mechanical systems controls, as well as the signal flare pistol mount and bomb salvo release handles.

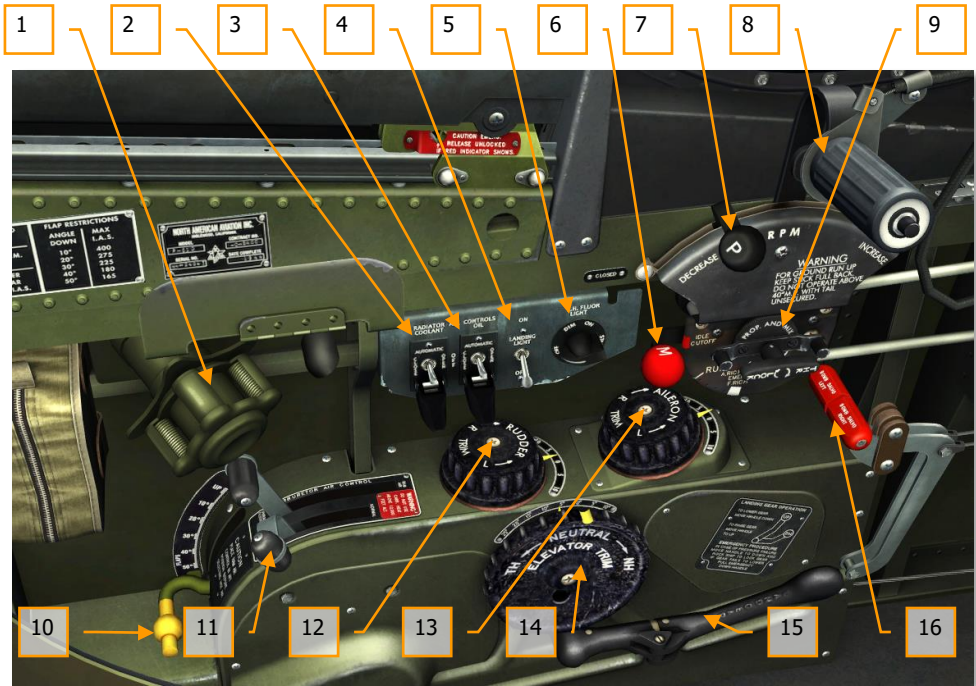
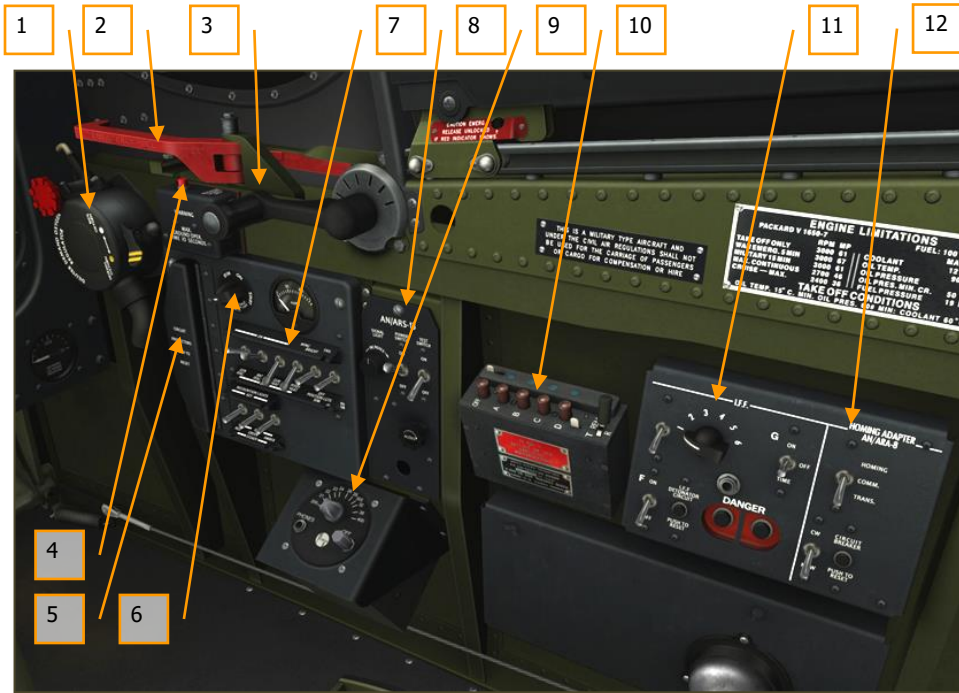

**Figure 34: P-51D Cockpit Left Side**

- |   |                               |
|---|-------------------------------|
| 1. Flare Pistol Mount                     | 9. Throttle Quadrant Locks    |
| 2. Coolant Radiator Air Control Switch    | 10. Flap Control Handle       |
| 3. Oil Radiator Air Control Switch        | 11. Carburetor Air Control    |
| 4. Landing Light Switch                   | 12. Rudder Trim Tab Control   |
| 5. Left Fluorescent Light Switch          | 13. Aileron Trim Tab Control  |
| 6. Mixture Control                        | 14. Elevator Trim Tab Control |
| 7. Propeller Control                      | 15. Landing Gear Control      |
| 8. Throttle handle with Microphone Button | 16. Bomb Salvo Release        |

## Right Side Legend

The right side of the cockpit includes the oxygen regulator, canopy controls, the electrical control panel with electrical system controls, and radio systems controls.



**Figure 35: P-51D Cockpit Right Side**

- |  |                                     |
|--|-------------------------------------|
| 1. Oxygen Regulator                    | 7. Electrical Control Panel         |
| 2. Emergency Canopy Release            | 8. Rear Warning Radar Control Panel |
| 3. Canopy Handcrank                    | 9. Detrola Control Box              |
| 4. Recognition Lights Keying Switch    | 10. VHF Control Box                 |
| 5. Circuit Breakers (under) Bump Plate | 11. IFF Control Panel               |
| 6. Right Fluorescent Light Switch      | 12. Homing Adapter Control Panel    |

## Front Dash Indicators and Controls

This section will overview in detail all of the indicators and controls located on the front dash.

### K-14 Gunsight

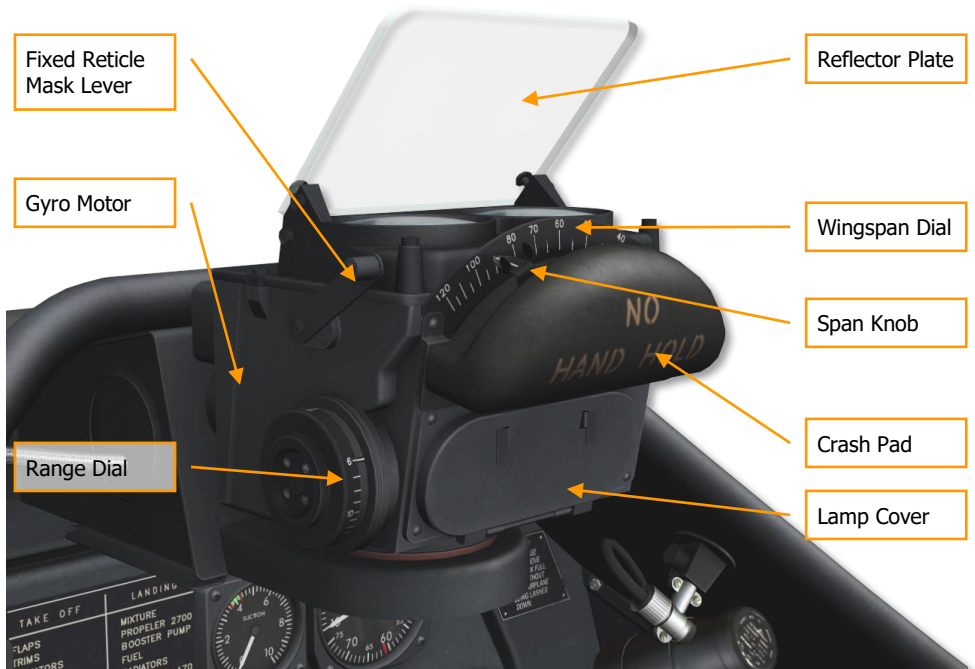

**Figure 36: K-14 Computing Gunsight**

The P-51D is equipped with the K-14 gunsight, mounted on the instrument hood centerline. This sight contains both fixed and gyro-actuated optical systems, and computes the correct lead angle for targets at ranges of 200 – 800 yards.

The fixed optical sight system projects on the reflector glass a cross, surrounded by a 70-mil ring which can be blanked out by pulling down the masking lever on the left side of the sight. The fixed sight is used to engage ground targets and as a secondary sight against airborne targets. The gyro sight projects a variable-diameter circle of six diamond-shaped pips surrounding a central dot. The gyro sight is the primary sight used to engage airborne targets.

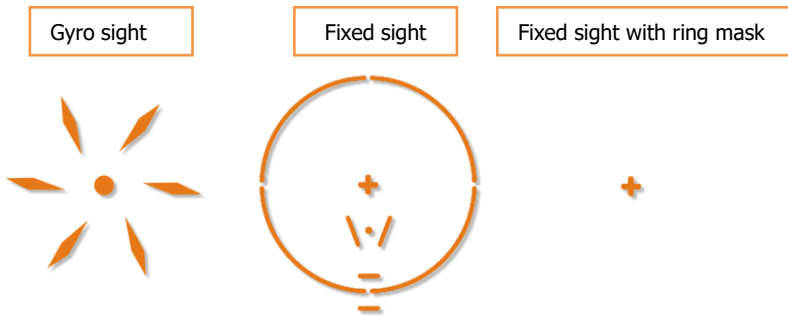

**Figure 37: K-14 Sight Reticles**

The reticle type and their brilliance are set on the Selector-Dimmer panel located under the left side of the instrument hood. This panel also contains a two-position toggle switch controlling the gyro mechanism. This switch should remain ON at all times.

The sight is adjusted for the size of the target by means of the wingspan scale on the front of the sight. Then range is set into the computing mechanism by rotating the throttle grip until the diameter of the gyro image coincides with the span of the target in view. Targets must be tracked for at least one second before the sight will compute effectively.

### Gunsight Selector-Dimmer Panel

The K-14 gunsight Selector-Dimmer panel is located below the left instrument shroud and is used to turn the sight on and off, set the sight mode, and adjust the sight brightness.



**Figure 38: K-14 Gunsight Selector-Dimmer Panel**

**GYRO SELECTOR SWITCH.** The sight gyro is controlled by the Gyro Selector switch with FIXED, FIXED & GYRO, and GYRO positions. The three positions allow the sight to be used as a fixed sight, combined fixed and compensating sight, or compensating sight only.

**GYRO MOTOR SWITCH.** Used to turn the gyro motor on and off by setting to ON or OFF positions.

**SIGHT DIMMER RHEOSTAT.** Used to adjust the sight brightness between DIM and BRIGHT settings.

**During landing, the Gyro Selector switch should be set to FIXED to prevent damage to the gyro.**

## Instrument Panel

Most of the primary instruments are mounted on the instrument panel, flight instruments being grouped together to the left, engine instruments to the right. Exceptions are the Hydraulic Pressure Gauge, which is below the Front Switch Panel; the Fuel Gauges, located on the floor and aft of the cockpit, and the Ammeter on the Electrical Switch and Circuit Breaker Panel.



**Figure 39: P-51D Cockpit Instrument Panel**

The instruments can be classified into four general groups: Vacuum System Instruments, Pitot Static System Instruments, Engine Instruments, and Miscellaneous Instruments.

## Vacuum System Instruments

Vacuum system instruments are operated by a vacuum pump driven by the engine and include the Flight Indicator, Bank and Turn Indicator, Directional Gyro, and Suction Gauge.

### Flight Indicator

The AN5736 Flight Indicator (Gyro Horizon Indicator) indicates a miniature plane and a gyro-actuated horizon bar. This instrument is used during instrument flying to indicate the longitudinal and lateral attitude of the aircraft. The horizon bar will indicate pitch up to 60° and bank up to 100°. The top needle of the instrument indicates the angle of bank on the bank scale, graduated from 0° to 90° and scaled to 30°. The cage knob is used to cage the instrument. To operate the cage knob, left-click on it to pull the knob out and roll the mouse wheel to turn it clockwise to the caged position. To uncage the instrument, roll the mouse wheel over the knob to turn it counter-clockwise. The horizon knob is used to adjust the horizon level. To operate the horizon knob, place the mouse over the knob and roll the mouse wheel to set the horizon higher or lower.

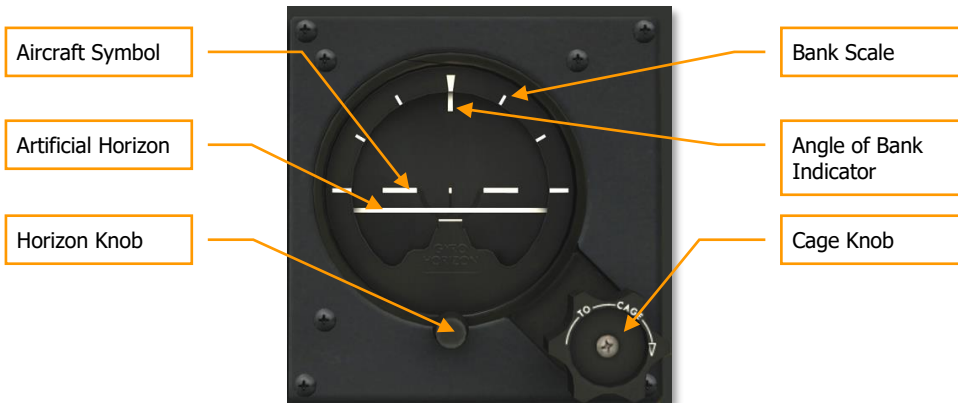

**Figure 40: Flight Indicator**

### Bank and Turn Indicator

The AN5820 bank-and-turn indicator is composed of a gyroscope-type turn indicator and a ball-type bank (slip) indicator. The bank indicator is a liquid-filled curved tube in which a free-rolling inclinometer ball changes position according to the direction of the force of gravity and centrifugal force. The bank indicator is used to minimize side-slip by keeping the ball centered between the center reference lines while turning. This instrument has no caging knob.



**Figure 41: Bank and Turn Indicator**

### Directional Gyro

The AN5735 Directional Gyro Indicator is used to supplement the magnetic compass in maintaining the aircraft on a straight course. The indicator is nonmagnetic. Relative movement of the aircraft from right to left shows on the circular card which is graduated in degrees the same as a compass card. This instrument is provided with a caging knob. The Gyro Indicator is uncaged for normal operation. The instrument can be caged to manually rotate the heading card. To cage the instrument, click on the caging knob to push it in and rotate the mouse wheel to adjust the heading.

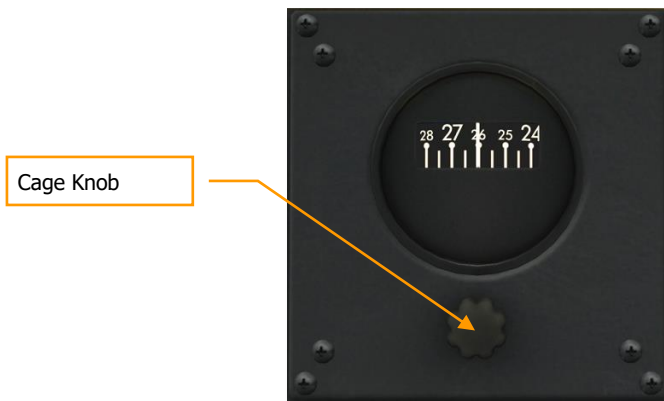

**Figure 42: Directional Gyro**

## Suction Gauge

The AN5771-5 vacuum system suction indicates whether the vacuum pump is providing proper vacuum for the system. The instrument is graduated from 0 to 10 and indicates pressure in inches of mercury (inHg). If the gauge reads less than 3.75 or more than 4.25, the pressure is abnormal and vacuum instrument readings are not reliable. Normal suction reading is 4.00 inHg.



**Figure 43: Suction Gauge**

## Pitot Static System Instruments

Pitot Static System Instruments are operated by pressure or static air from the pitot tube, which is located under the right wing and from the static plates on the fuselage skin. They include the Airspeed Indicator, Altimeter, and Rate of Climb Indicator.

### Airspeed Indicator

The Type F-2 Airspeed Indicator is a sensitive differential pressure gauge that measures the difference between pitot tube impact air pressure and static air pressure. The indicator displays Indicated Airspeed (IAS) and is graduated from 0 to 700 mph. The scale is to 10 mph from 50 to 300 mph and to 50 mph thereafter. The red line indicates the maximum permissible IAS of 505 mph at an altitude of 5,000 ft and less.





**Figure 44: Airspeed Indicator**

**Red line IAS lowers as altitude increases above 5,000 ft. Always anticipate a lower maximum permissible IAS as altitude increases above 5,000 ft!**

**Altimeter**

The AN5760-2 altimeter determines the altitude at which the aircraft is flying by measuring atmospheric pressure. The instrument consists of 3 needles; the shortest needle indicates altitude in tens of thousands of feet, the medium needle indicates altitude in thousands of feet, and the long needle indicates altitude in hundreds of feet. For example, the image below indicates 29,500 ft.

The instrument includes a Kollsman window on the right side of the face to indicate the sea level reference pressure in inches of mercury (inHg). The reference pressure can be adjusted by turning the reference pressure knob.



**Figure 45: AN5760-2 Pressure Altimeter indicating 29,500 ft.**

## Rate of Climb Indicator

The AN5825 Rate of Climb Indicator shows the rate of ascent or descent of the aircraft. The instrument is graduated from 0 to 6,000 ft. in both positive and negative directions and indicates vertical speed in feet per minute. The face is scaled to 100 ft between 0 and 1,000 ft, and to 500 ft thereafter. The Rate of Climb Indicator is used to maintain a constant altitude when turning and to establish a definite and constant rate of climb or descent when flying on instruments.



**Figure 46: Rate of Climb Indicator**

## Engine Instruments

The engine instruments include the Manifold Pressure Indicator, Tachometer, Carburetor Air Temperature Indicator, Coolant Temperature Indicator, and the Engine Gauge.

### Manifold Pressure Indicator

The Manifold Pressure Indicator is used to set the desired engine power setting by adjusting the throttle. As the throttle handle is moved forward, a throttle butterfly opens and allows more air to flow through the carburetor to be compressed by the supercharger and delivered to the manifold for combustion in the cylinders.

The Type D-10 Manifold Pressure Indicator is a vaporproof, absolute-pressure instrument. The gauge measures pressure in inches of mercury (inHg) and is graduated from 10 to 75 inHg. The face is scaled to 1 inHg. The green range indicates the normal operating range of 26-36 inHg. The red line indicates full military power of 61 inHg. When running in War Emergency Power, the manifold pressure can be increased to a maximum of 67 inHg.



**Figure 47: Manifold Pressure Indicator**

### Tachometer

The Tachometer provides remote indication of engine speed. The instrument is graduated from 0 to 4500 and indicates engine speed as Revolutions Per Minute (RPM) in hundreds of RPM. The face is scaled to 100 RPM throughout. The green range indicates normal operating RPM of 1600 - 2400. The red line indicates maximum normal RPM of 3000.



**Figure 48: Tachometer**

#### Carburetor Air Temperature Indicator

The AN5790-6 Carburetor Air Temperature Indicator shows the temperature of the air running through the carburetor air scoop. The gauge indicates temperature in degrees Celsius ( $^{\circ}\text{C}$ ) and is graduated from  $-70^{\circ}$  to  $150^{\circ}\text{C}$ . The face is scaled to  $10^{\circ}\text{C}$ . The green range indicates normal operating temperature of  $10^{\circ}$  -  $30^{\circ}\text{C}$ . The red line indicates maximum temperature of  $40^{\circ}\text{C}$ .



**Figure 49: Carburetor Air Temperature Indicator**

#### Coolant Temperature Indicator

The Coolant Temperature Indicator shows the temperature of the coolant fluid. The gauge indicates temperature in degrees Celsius ( $^{\circ}\text{C}$ ) and is graduated from  $-70^{\circ}$  to  $150^{\circ}\text{C}$ . The face is scaled to  $10^{\circ}\text{C}$ . The green range indicates normal operating temperature of  $100^{\circ}$  -  $110^{\circ}\text{C}$ . The red line indicates maximum coolant temperature of  $121^{\circ}\text{C}$ .



**Figure 50: Coolant Temperature Indicator**

### Engine Gauge

The engine gauge consists of three instruments in one – showing oil temperature, oil pressure, and fuel pressure.



**Figure 51: Engine Gauge**

**OIL TEMPERATURE GAUGE.** The Oil Temperature Gauge dominates the top half of the Engine Gauge. The gauge is graduated from 0 to 100 and indicates oil temperature in degrees Celsius (°C). The gauge is scaled to 5°. The green range indicates normal operating temperature of 70° - 80°C. The red line indicates maximum oil temperature of 90°C.

**OIL PRESSURE GAUGE.** The Oil Pressure Gauge is located on the lower left side of the Engine Gauge. The gauge indicates oil pressure in pounds per square inch (PSI) and is graduated from 0 to 200 PSI. The gauge is scaled to 10 PSI throughout. The green range indicates normal operating

pressure of 70-80 PSI. The red lines indicate a minimum permissible pressure of 50 PSI and a maximum permissible pressure of 90 PSI.

**FUEL PRESSURE GAUGE.** The Fuel Pressure Gauge is located on the bottom right side of the Engine Gauge. The gauge indicates fuel pressure in pounds per square inch (PSI) and is graduated from 0 to 25 PSI. The gauge is scaled to 1 PSI. The green range indicates normal operating pressure of 12 - 16 PSI. The red lines indicate a minimum permissible pressure of 12 PSI and a maximum permissible pressure of 19 PSI.

## Miscellaneous Instruments

Miscellaneous instruments include the Remote Indicator Compass, Clock, Oxygen Flow Indicator, Oxygen Pressure Gauge, Hydraulic Pressure Gauge, Fuel Gauges, Ammeter, and Accelerometer.

### Remote Indicator Compass

The Remote Indicator Compass on the P-51D replaces the conventional magnetic compass of previous aircraft, although some models also include a conventional standby magnetic compass as a backup. The remote compass unit is installed in the left wing and transmits its readings electrically to the indicator on the instrument panel. This type of compass doesn't float around and fluctuate when the aircraft is maneuvered. This provides all of the advantages of the directional gyro without the precessions. However, the directional gyro is provided as a backup should the electrical system fail.

The Remote Indicator Compass consists of a stationary compass rose, a current magnetic heading arrow, and a desired magnetic heading arrow. The knob of the instrument is used to adjust (turn) the desired magnetic heading arrow to a desired heading.

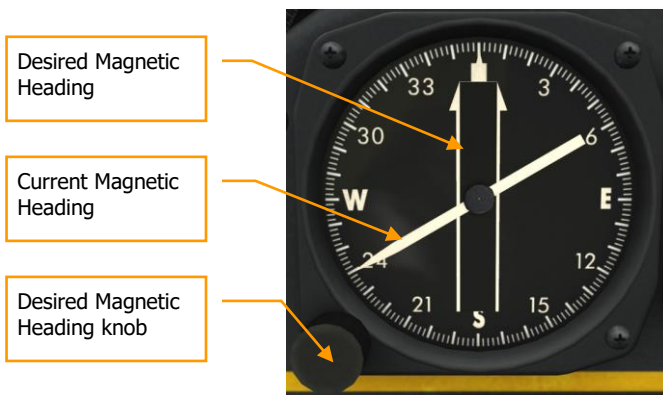
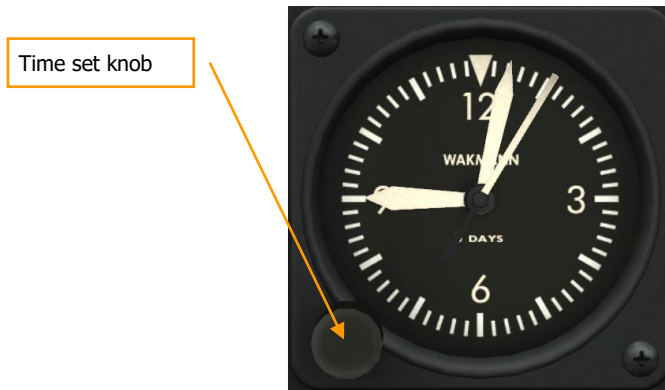

**Figure 52: Remote Indicator Compass**

### Clock

The clock is installed in the upper left section of the instrument panel. The winding knob is used to set the time. To operate the knob, pull the knob out with a left mouse button click and roll the mouse

wheel to set the time, then return the knob into the pressed position with another click of the left mouse button.



**Figure 53: Clock**

### Oxygen Flow Indicator

The Oxygen Flow Indicator is located immediately to the left of the Oxygen Pressure Gauge on the bottom right corner of the instrument panel. This indicator shows the flow of oxygen as it is inhaled and exhaled by the pilot. When the pilot inhales, the blinkers open as oxygen is moved through the system. As the pilot exhales and oxygen stops flowing, the blinkers close.



**Figure 54: Oxygen Flow Indicator**

### Oxygen Pressure Gauge

The Oxygen Pressure Gauge is located on the bottom right corner of the instrument panel and indicates pressure in the oxygen system. The gauge measures pressure in pounds per square inch

(PSI). The instrument is graduated from 0 to 500 PSI and scaled to 50 PSI. Normal full pressure of the system is 400 PSI. Note, oxygen pressure readings can drop as altitude increases due to the cooling of the oxygen tanks. Conversely, the pressure can increase as altitude decreases due to the warming of the tanks. A rapid decrease of oxygen pressure in level flight or during a descent is abnormal and may indicate an oxygen system leak or malfunction.



**Figure 55: Oxygen Pressure Gauge**

#### Hydraulic Pressure Gauge

The Hydraulic Pressure Gauge is located on the bottom of the front dash, above the Parking Brake handle. This instrument indicates fluid pressure in the hydraulic system, measured in pounds per square inch (PSI). The instrument is graduated from 0 to 2,000 PSI and scaled to 200 PSI throughout. Normal pressure for the hydraulic system is 1,050 (+/- 50) PSI.

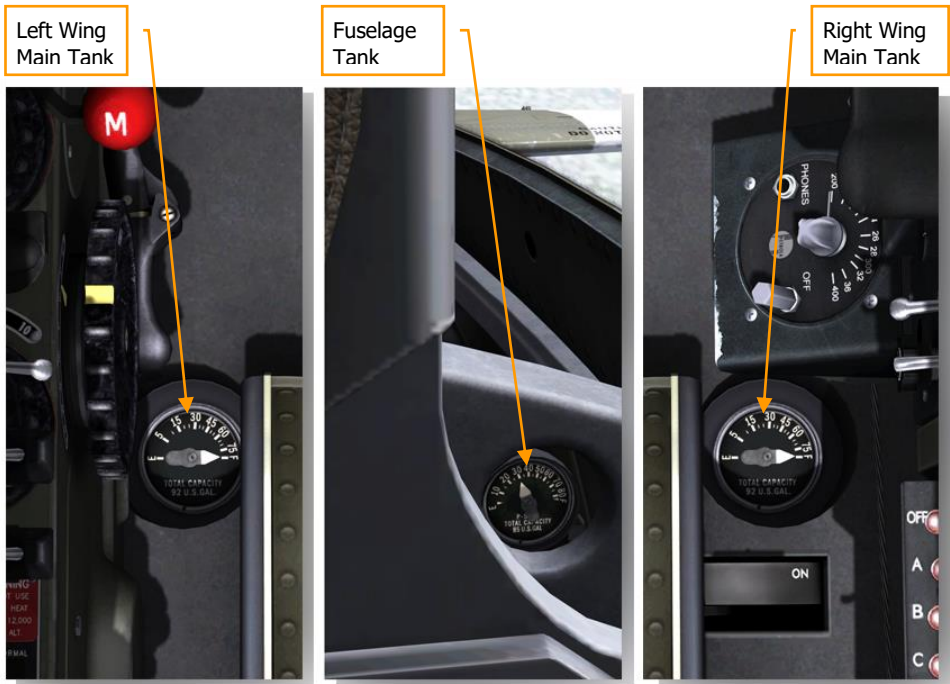

**Figure 56: Hydraulic Pressure Gauge**



## Fuel Gauges

A fuel gauge is connected to each main tank and the fuselage tank. The fuel gauges for the main (wing) tanks are located on the cockpit floor on either side of the seat. The fuel gauge for the fuselage tank is located behind the seat on the pilot's left side.



**Figure 57: Fuel Gauges**

## Accelerometer

The AN-5745 accelerometer indicates the load factor (G forces) acting on the airframe. The gauge is graduated from -5 to 12G and is scaled to 1G throughout. The instrument includes three needles to indicate current G, and maximum and minimum G readings recorded since the last reset. The Reset knob is used to reset the maximum and minimum needles. To operate the Reset knob, perform a left mouse button click over it. Two red lines indicate maximum permissible loads of -4G and +8G.

Reset knob

**Figure 58: Accelerometer**

## Engine Control Panel

The Engine Control Panel is located at the bottom left of the front dash and includes a number of switches to control engine systems.

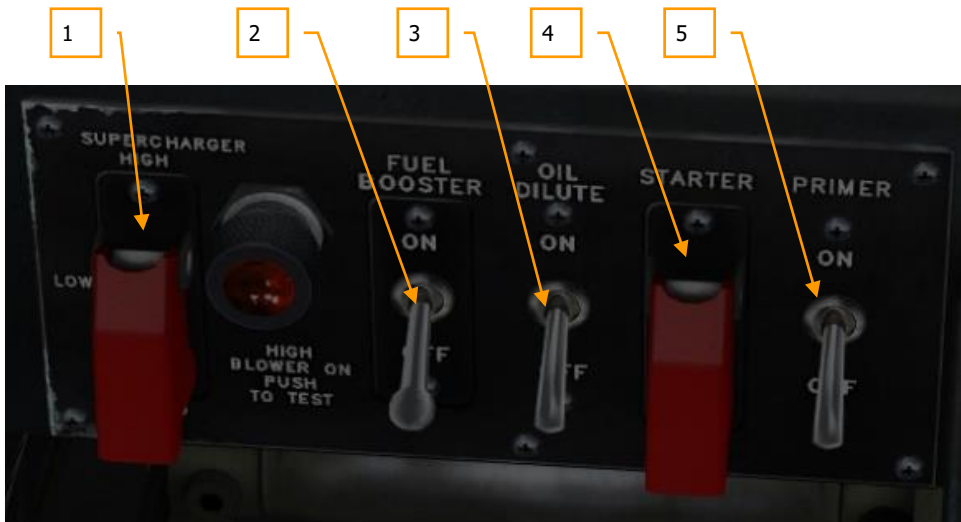
**Figure 59: Engine Control Panel**

**1. SUPERCHARGER BLOWER SWITCH.** The Supercharger Blower switch has three positions: AUTO, LOW, and HIGH.

- **AUTO.** In AUTO mode, the supercharger operates automatically, switching from Low to High blower at an altitude of 14,500 to 19,500 feet, depending on the amount of ram air. The supercharger switches from High to Low blower at an altitude approximately 1,500 feet below that at which High blower engages to prevent repeated activation of High and Low blower modes at borderline altitudes. AUTO mode is the normal setting for the supercharger.
- **LOW.** Setting the switch to LOW sets the supercharger to Low blower mode manually. Operating the supercharger in Low blower mode may be desirable for maximum fuel efficiency when conducting long-range flights.
- **HIGH.** Setting the switch to HIGH sets the supercharger to High blower mode manually. The switch must be held in the High position to maintain High blower mode. Releasing the switch will revert the supercharger to Low blower mode.

An amber jewel indicator light next to the switch turns on when the supercharger is in high blower. The indicator can be tested by pressing inward.

For a more detailed description of the supercharger system, see the [Supercharger](#) section of the aircraft overview.

**2. FUEL BOOSTER SWITCH.** Setting the Fuel Booster switch to the ON (up) position provides electrical power to the booster pumps in the two main and one fuselage tanks. Each booster pump is engaged by selecting the corresponding tank using the Fuel Selector Valve at the bottom of the front dash.

For a more detailed description of the fuel system, see the [Fuel System](#) section of the aircraft overview.

**3. OIL DILUTE SWITCH.** Setting the Oil Dilute switch to the ON (up) position thins the oil with gasoline, which may be necessary when starting the engine at temperatures of 40°F and lower. For a more detailed description of the oil system, see the [Oil System](#) section of the aircraft overview.

**4. STARTER SWITCH.** The Starter switch is used to start the engine. The switch is spring-loaded and needs to be held in the ON (up) position to execute a start.

**Do not operate the starter for over 15 seconds continuously.**

**5. PRIMER SWITCH.** The Primer switch is used to prime the engine with fuel. The switch is spring-loaded and needs to be held in the ON (up) position to execute a prime. When the primer switch is held ON, fuel passes to the primer lines and into the induction manifold. Usually 3 or 4 seconds are sufficient to prime a cold engine. One second is usually sufficient for a warm engine. The engine should be primed only when it is turning over.

## Front Switch Panel

The front switch panel includes a number of weapons control switches, as well as the Ignition Selector switch, Cockpit Lights switch, and the Horn Silence button.

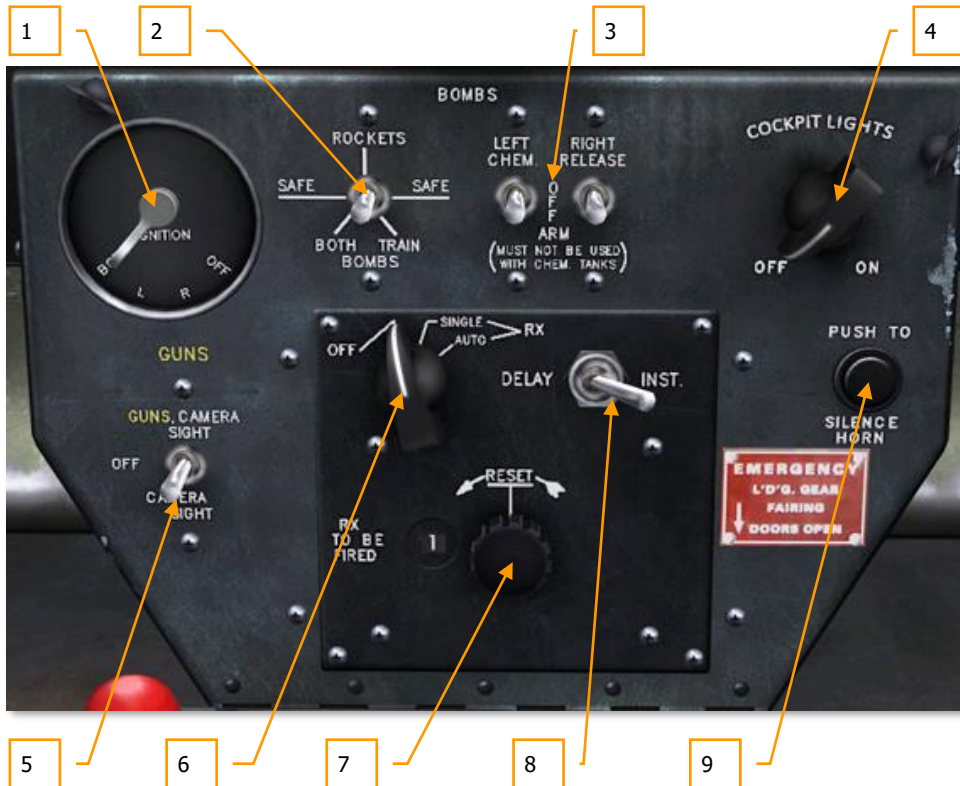

**Figure 60: Front Switch Panel**

**1. IGNITION SELECTOR SWITCH.** The Ignition Selector switch controls the magnetos used to supply power to the engine ignition system and has four possible positions: OFF, R (right), L (left), and BOTH.

- **OFF.** The magnetos are turned off.
- **R.** The right magneto is used to start the engine.
- **L.** The left magneto is used to start the engine.
- **BOTH.** Both magnetos are used to start the engine.

Normally both magnetos are used to start the engine.

**2. BOMB-ROCKET SELECTOR SWITCH.** The Bomb-Rocket Selector switch controls the selection of external weapons for fire and has four possible positions: SAFE, ROCKETS, BOMBS BOTH, and BOMBS TRAIN.

- **SAFE.** When set to safe, external weapons are not released.
- **ROCKETS.** When set to rockets, rockets are fired according to the release settings set on the Rocket Control Panel.
- **BOMBS BOTH.** When set to BOMBS BOTH, both bombs or drop tanks are dropped simultaneously with a single press of the Bomb-Rocket Release button.
- **BOMBS TRAIN.** When set to BOMBS TRAIN, the left bomb or drop tank is released with the first press of the Bomb-Rocket Release button and the right bomb or drop tank is released with the second press of the Bomb-Rocket Release button.

**3. BOMB ARMING SWITCHES.** The Bomb Arming switches control the arming of the left and right bombs, as well as initiate release of chemicals or smoke from the left and right external chemical tanks. The switches have three possible positions: OFF, ARM, and CHEM RELEASE.

- **OFF.** Bombs are not armed. This position can be used to jettison bombs in unarmed state.
- **ARM.** Bombs are armed for detonation. This position must not be set for chemical tanks.
- **CHEM RELEASE.** When carrying external chemical or smoke tanks, setting the left or right switch to CHEM RELEASE will initiate chemical or smoke release from the selected canister. Once chemical or smoke release is confirmed visually, the switch can be returned to OFF. Chemical or smoke release will continue until the tank is depleted.

**4. COCKPIT LIGHTS SWITCH.** The cockpit lights switch controls the state and intensity of the two cockpit lights.

**5. GUN SAFETY SWITCH.** The gun safety switch controls the arming of the guns and operation of the gun camera. The switch has three possible positions: OFF, GUNS & CAMERA SIGHT, and CAMERA SIGHT.

- **OFF.** The guns are not fired and the gun camera is not operated.
- **GUNS & CAMERA SIGHT.** In this position, pressing the gun trigger all the way down will fire the guns and operate the gun camera simultaneously.
- **CAMERA SIGHT.** In this position, pressing the gun trigger all the way down will operate the gun camera, but not fire the guns.

**6. ROCKET RELEASE CONTROL SWITCH.** The Rocket Release Control switch controls the rocket release mode and has three possible positions: OFF, SINGLE, and AUTO.

- **OFF.** Rockets are not fired.
- **SINGLE.** A single rocket is fired with each press of the Bomb-Rocket Release switch. The specific rocket to be fired can be set using the Rocket Counter Control knob.

- **AUTO.** In Auto mode, rockets are fired in train (ripple) as long as the Bomb-Rocket Release switch is held down. All ten rockets are fired within approximately one second.

**7. ROCKET COUNTER.** The Rocket Counter window indicates the next rocket to be fired according to station number. The left wing stations include #1, 3, 5, 7, and 9. The right wing stations include #2, 4, 6, 8, and 10. Note, stations 7, 8, 9, and 10 are not installed when bombs are carried. The knob of the Rocket Control Counter panel is used to set the desired rocket station for fire. This should be set to 1 at the start of a mission.

**8. ROCKET DELAY SWITCH.** The Rocket Delay switch is used to set the fuse mode for rockets. When set to DELAY, the rocket detonates a moment after impact. When set to INST, detonation is instantaneous upon impact.

**9. HORN SILENCE BUTTON.** The Horn Silence button is used to silence the landing gear alert horn.

## Fuel Shutoff and Selector Valves

Fuel flow to the engine is controlled by the Fuel Shutoff Valve and the Fuel Selector Valve, both located at the bottom of the front dash, in front of the control stick.



**Figure 61: Fuel Shutoff and Selector Valves**

**FUEL SHUTOFF VALVE.** The Fuel Shutoff Valve lever is mechanically linked to the fuel shutoff valve in the left wheel well. The fuel shutoff valve controls fuel flow from all tanks to the engine-driven pump. The valve can be set to either ON (open) or OFF (closed).

**FUEL SELECTOR VALVE.** The Fuel Selector Valve controls which tank is feeding fuel to the engine. Only one tank can be selected at a time. Possible settings include:

- **FUS. TANK** - Fuselage Tank
- **MAIN TANK L.H.** - Main Left Tank
- **MAIN TANK R.H.** - Main Right Tank
- **R.H. COMBAT DROP TANK** - Right Drop Tank
- **L.H. COMBAT DROP TANK** - Left Drop Tank

The fuel gauges for the two main (wing) tanks are located on the cockpit floor on either side of the pilot's seat. The fuel gauge for the fuselage tank is located aft of the seat, behind the pilot's left shoulder.

## Landing Gear Warning Lights

The Landing Gear Warning lights, located at the bottom of the instrument panel, are used to alert the pilot about the state of the landing gear system. The red Unsafe light will turn on and a horn alert will sound in the cockpit when the throttle is retarded below the minimum cruise condition while the landing gear doors are closed and the gear is up and locked, or at any throttle position if the landing gear doors are open and the gear is down and unlocked or up and locked.

The below chart illustrates the possible conditions of the Landing Gear Warning lights:

THROTTLE AND GEAR STATE		SAFE/UNSAFE LIGHT
<b>Throttle</b> <b>Doors</b> <b>Gear</b>  <b>Signal</b>	Retarded Closed Up and locked or down and unlocked  <b>UNSAFE</b>	
<b>Throttle</b> <b>Doors</b> <b>Gear</b>  <b>Signal</b>	Any position Open Down and unlocked or up and locked  <b>UNSAFE</b>	
<b>Throttle</b> <b>Doors</b> <b>Gear</b>  <b>Signal</b>	Any position Any position Down and locked  <b>SAFE</b>	

<b>Throttle</b>	Advanced	
<b>Doors</b>	Closed	
<b>Gear</b>	Up and locked	
<b>Signal</b>	NONE	

## Parking Brake

The Parking Brake handle is located just to the right of the Landing Gear Warning Lights at the bottom center of the instrument panel.



**Figure 62: Parking Brake**

To engage the parking brake, pull the parking brake handle out, depress the brake pedals, release the brake pedals, and then release the parking brake handle. To release the parking brake, simply depress the pedals.

**Never set the parking brake when the brakes are hot. The brake discs may freeze.**

## Landing Gear Fairing Door Emergency Release Handle

The Landing Gear Fairing Door Emergency Release Handle is located at the bottom of the instrument panel, adjacent to the Fuel Selector Valve and just above the Hydraulic Pressure Gauge. This handle can be used in case of hydraulic system failure to mechanically release the hydraulic pressure and fairing doors after the landing gear handle is placed in the DN (down) position. As the gear is lowered, yawing the aircraft may be required to ensure the gear locks in position. The release handle is also used after the aircraft is parked, to release the hydraulic pressure and open the fairing doors. Opening the fairing doors mechanically locks the Landing Gear handle in the down position.





**Figure 63: Landing Gear Fairing Door Emergency Release Handle**

## Left Side Controls

This section will describe in detail the controls located on the left side of the cockpit.

### Throttle Quadrant

The throttle quadrant includes the Throttle Control handle with the radio push-to-talk button, Propeller Control lever, Mixture Control lever, and friction locks.

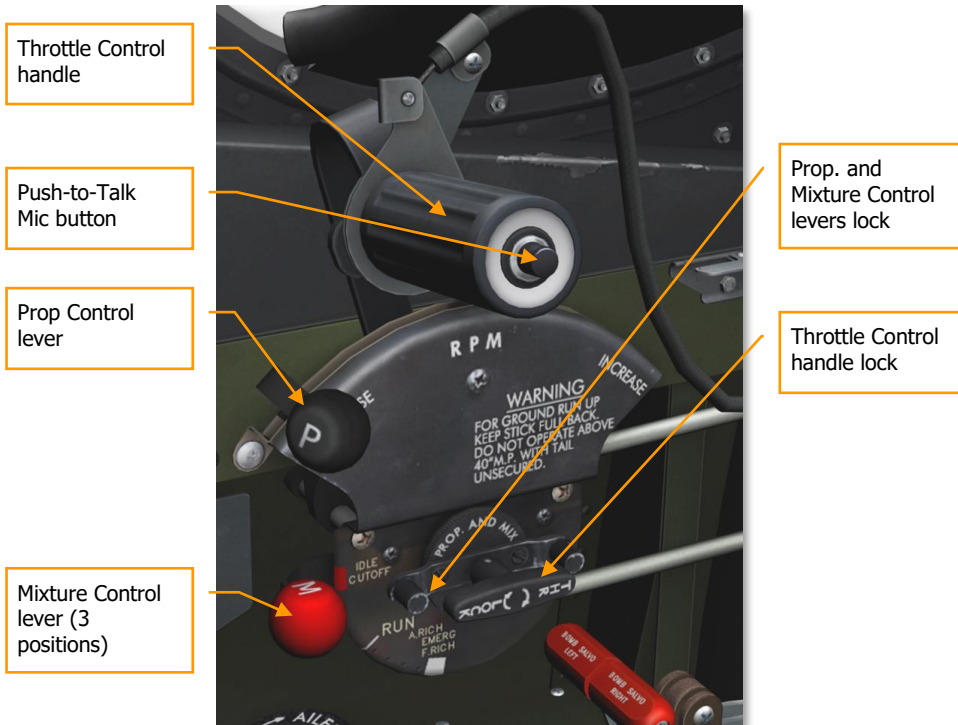

**Figure 64: Throttle Quadrant**

**THROTTLE CONTROL HANDLE.** The Throttle Control handle is used to set the desired manifold pressure by opening and closing the throttle butterfly of the engine. A throttle stop assembly on the upper longeron allows full travel of the throttle control lever to obtain 67 inHg manifold pressure. However, a throttle gate on the longeron stops the lever at the 61 inHg manifold pressure position - the full military power setting. A safety wire is installed across the gate at this position and as the gate is passed to obtain War Emergency Power (up to 67 inHg manifold pressure), the wire will be broken, indicating that 61 inHg manifold pressure has been exceeded.

The throttle handle features a twist grip, which is used to adjust the range setting for the K-14 gunsight.

**RADIO PUSH-TO-TALK BUTTON.** The throttle handle includes the radio push-to-talk button, which activates the VHF transmitter when pressed.

**THROTTLE CONTROL HANDLE LOCK.** The Throttle Control handle lock is used to adjust the amount of friction on the Throttle Control handle.

**PROP. AND MIXTURE CONTROL LEVERS LOCK.** The Prop. and Mixture Control levers lock is used to adjust the friction of the Propeller Control lever and the Mixture Control lever.

**PROPELLER CONTROL LEVER.** The Propeller Control lever is used to set the propeller RPM. The propeller governor is designed to maintain 1800 RPM at the low setting and 3000 RPM at the high setting. The governor automatically adjusts the propeller pitch to maintain the set RPM. High RPM settings are used when maximum performance is desired, such as takeoff or combat, while lower RPM settings are used to maximize fuel economy and engine wear during less demanding flight stages. For standard MP and RPM settings, consult the [engine ratings chart](#).

**MIXTURE CONTROL LEVER.** The Mixture Control lever is used to set the fuel/air mixture. On earlier aircraft, the lever has four possible positions: IDLE CUTOFF, AUTO LEAN, AUTO RICH, and FULL RICH. On later aircraft, the AUTO LEAN and AUTO RICH positions have been replaced by a single RUN position.

- **IDLE CUTOFF.** The IDLE CUTOFF position is used when starting and stopping the engine. This position should be set after the engine is stopped to ensure that no fuel is allowed to enter the carburetor while the engine is not running.
- **RUN.** The RUN position is the standard operating setting for the engine and is normally used for takeoff, climb, landing, and combat.
- **FULL RICH.** The FULL RICH position is an emergency setting to be used only in case of carburetor failure to ensure a sufficient fuel supply to the engine.

## Radiator Air Control Panel

The Radiator Air Control panel includes the Coolant Radiator Air Control switch, the Oil Radiator Air Control switch, the Landing Light switch, and the Left-hand Cockpit Fluorescent Light Rheostat.

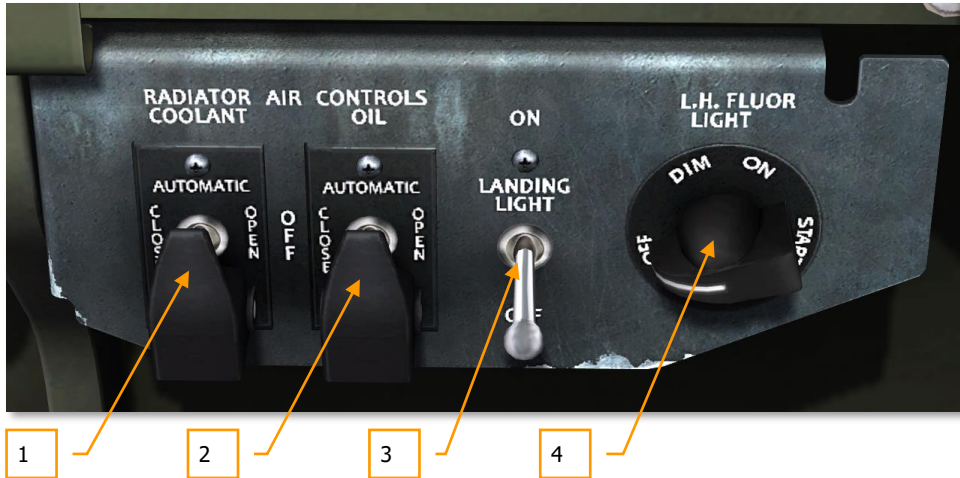

**Figure 65: Radiator Air Control Panel**

**1. COOLANT RADIATOR AIR CONTROL SWITCH.** Airflow through the dual radiator is controlled by an electric actuator which is mechanically connected to the coolant flap in the rear of the air scoop. Operation of the actuator is controlled by the Coolant Radiator Air Control switch on the Radiator Air Control panel. The switch has four possible positions: AUTOMATIC, OPEN, CLOSE, and OFF.

- **AUTOMATIC.** This is the standard position of the switch and should be set for all normal operations. The switch is held in this position by a spring-loaded guard. With the switch set to AUTOMATIC, the temperature of the coolant governs the amount the coolant flap will be opened or closed.
- **OPEN.** The OPEN position of the switch is spring-loaded and must be held in this position manually in order to further open the coolant flap. Releasing the switch from the OPEN position will automatically set it to the OFF position. The OPEN position can be used for ground operations or if manual adjustment of the coolant flap is necessary in flight.
- **CLOSE.** The CLOSE position of the switch is spring-loaded and must be held in this position in order to further close the coolant flap. Releasing the switch from the CLOSE position will automatically set it to the OFF position. The CLOSE position can be used for ground operations or if manual adjustment of the coolant flap is necessary in flight.
- **OFF.** Control of the radiator coolant flap is disabled.

**2. OIL RADIATOR AIR CONTROL SWITCH.** The Oil Radiator Air Control switch controls the electric actuator of the oil radiator air outlet flap, located midway along the bottom of the air scoop. The switch has four possible positions: AUTOMATIC, OPEN, CLOSE, and OFF.

- **AUTOMATIC.** This is the standard position of the switch and should be set for all normal operations. When set to AUTOMATIC, a thermostat automatically starts and stops the actuator to move the oil radiator air outlet flap, depending on oil temperature.
- **OPEN.** The oil radiator air outlet flap can be opened manually by setting the switch to the OPEN position in case automatic control of the flap fails, resulting in an abnormal oil temperature reading on the Engine Gauge.
- **CLOSE.** The oil radiator air outlet flap can be closed manually by setting the switch to the CLOSE position in case automatic control of the flap fails, resulting in an abnormal oil temperature reading on the Engine Gauge.
- **OFF.** Control of the oil radiator air outlet flap is disabled.

**3. LANDING LIGHT SWITCH.** The Landing Light switch is used to turn the landing light on and off by setting the switch to the corresponding position. Retraction and extension of the landing light is controlled automatically by mechanical means when the gear is operated. A safety switch is incorporated into the landing light circuit to cut off current to the light when it is retracted.

**Keep ground operation of the landing light to a minimum to prevent overheating and damaging the unit.**

**4. LEFT-HAND FLUORESCENT LIGHT RHEOSTAT.** This rheostat controls the left fluorescent instrument panel light. To turn the light on, first set the rheostat to the START position, then adjust intensity between the ON and DIM settings. Note, the right fluorescent light is controlled by the Right-hand Fluorescent Light rheostat located on the [Electrical Control panel](#).

## Trim Tab Controls

Trim tab controls are installed on the left side of the cockpit to control the elevator, rudder, and aileron trim tabs.



**Figure 66: Trim Tab Controls**

**ELEVATOR TRIM TAB CONTROL WHEEL.** The elevator trim tab control wheel is mounted in a vertical plane on the left console and is connected to the elevator trim tabs by dual cables. Rolling the wheel forward in the direction of the NH arrow makes the aircraft nose-heavy. Rolling the wheel in the direction of the TH arrow causes a tail-heavy condition.

**RUDDER TRIM TAB CONTROL KNOB.** The rudder trim tab control knob is located horizontally on the left console and is marked "R" (right) and "L" (left) with indicating arrows. A geared pointer indicates the number of degrees the trim tab is moved.

**AILERON TRIM TAB CONTROL KNOB.** The aileron trim tab control knob is located horizontally on the left console and is marked "R" (right) and "L" (left) with indicating arrows. A geared pointer indicates the number of degrees the trim tab on the left aileron is moved (the trim tab on the right aileron is ground-adjustable).

## Carburetor Air Controls

Cold outside ram air enters a duct in the nose just below the propeller spinner and moves toward the carburetor for induction into the engine. In case of dust or icing conditions, a door at the forward end of the duct can be closed mechanically from the cockpit using the Ram Air Control lever to force the air to enter through perforated side panels (and filters) on each side of the engine cowl. An additional door further down the duct can be opened using the Hot Air Control lever to allow warm air from the engine compartment to enter the carburetor. If hot air is used, the Ram Air Control lever should be set to UNRAMMED FILTERED AIR to prevent cold ram air from entering the carburetor.



**Figure 67: Carburetor Air Controls**

**RAM AIR CONTROL LEVER.** The Ram Air Control lever opens and closes the ram air door in the forward section of the carburetor air duct. The lever has two positions: RAM AIR and UNRAMMED FILTERED AIR. In the RAM AIR position, the front intake is open and ram air enters the duct toward the carburetor. In the UNRAMMED FILTERED AIR position, the ram air door is closed and air passes through the side filters to the carburetor. Normal flying operations should be conducted using ram air (lever set to RAM AIR). UNRAMMED FILTERED AIR can be used in severe icing or dust conditions.

**HOT AIR CONTROL LEVER.** The Hot Air Control lever has two positions: NORMAL and HOT AIR. When set to NORMAL, the hot air door is closed and either ram air or unrammed filtered air enters the carburetor, depending on the Ram Air Control lever setting. When set to HOT AIR, the hot air door is open and warm air from the engine compartment enters the carburetor. Note, the warm air door is spring-loaded and will open automatically in case of icing or other foreign object obstruction due to the suction on the carburetor.

**Do not use HOT AIR at altitudes above 12,000 ft. Doing so may affect the carburetor's altitude compensation and result in an overly lean fuel mixture.**

## Flaps Control

The Wing Flaps handle is located on the left side of the cockpit, aft of the console. The handle has six positions: UP, 10°, 20°, 30°, 40°, and 50°. A detent is constructed for each position. Note, normal takeoff is performed with the flaps up. Flaps can be set to 15 - 20° down for a minimum-run takeoff.



**Figure 68: Flaps Control**

## Bomb Salvo Handles

Two Bomb Salvo handles are located aft of the instrument panel on the left side of the cockpit and can be used to release bombs or drop wing tanks mechanically in case of an emergency when a normal electrical release using the Bomb-Rocket Release switch fails. The two handles are mounted side by side and may be operated simultaneously with one hand. To drop bombs in a safe condition, ensure the Bomb Arming switches are set to OFF.





**Figure 69: Bomb Salvo Handles**

## Landing Gear Handle

The Landing Gear handle is located on the left side of the cockpit just forward of the seat and is used to raise and lower the landing gear. The handle has two positions - UP and DN (down). The gear handle positions the landing gear selector valve through a mechanical linkage. The handle is spring-loaded into a detent in its quadrant and must be pulled inboard to be moved from one position to another. The handle is mechanically locked in the down position when the [Landing Gear Fairing Door Emergency Release handle](#) is pulled (fairing doors open). This prevents accidentally raising the handle while the aircraft is on the ground. While the aircraft is moving on the ground, the landing gear *will retract if the landing gear handle is set to UP.*



Figure 70: Landing Gear Handle

## Right Side Controls

This section will describe in detail the controls located on the right side of the cockpit.

### Canopy Controls

The cockpit canopy controls include the Canopy Handcrank and the Canopy Emergency Release handle.

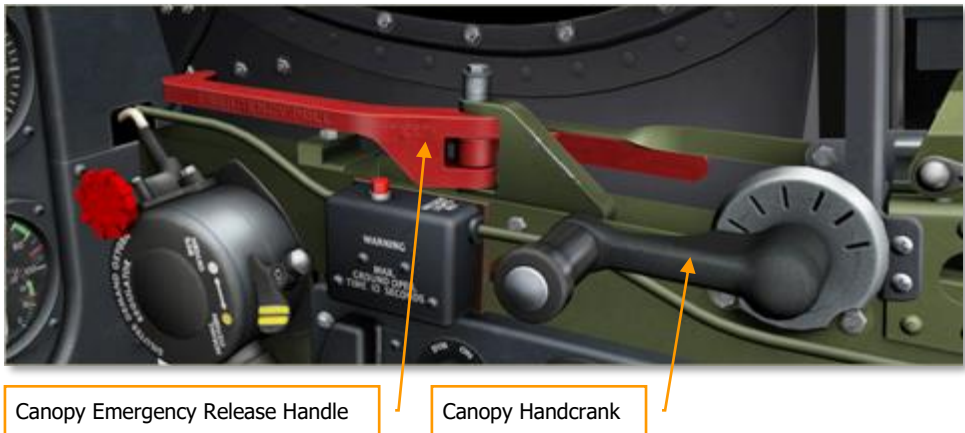

**Figure 71: Canopy Controls**

**CANOPY HANDCRANK.** The Canopy Handcrank is used to open and close the canopy from inside the cockpit in normal and safe conditions. The handcrank includes a latch on the handle, which must be depressed prior to turning the handle. The canopy slides fore and aft and can be set in any desired position along the slide rails. The canopy can be locked in an open position by releasing the crank latch and completing a turn to a locking position.

**CANOPY EMERGENCY RELEASE HANDLE.** The red Canopy Emergency Release handle is located just ahead of the Canopy Handcrank. The handle is operated by pulling toward the pilot. This results in a mechanical release of the latches holding the canopy and permits the slipstream to carry the canopy clear of the aircraft.

### Oxygen Regulator

The AN6004 oxygen regulator is installed on the right side of the cockpit, just aft of the instrument panel. The oxygen regulator has a diaphragm which actuates a valve, permitting oxygen to flow through the regulator, where it mixes with free air in varying amount in accordance with barometric pressure. A control valve allows the pilot to close the air intake, thus causing pure oxygen to flow to the mask. The regulator also has an emergency valve, which causes oxygen to by-pass the regulator

and flow directly to the mask. A feed line directs oxygen to the Oxygen Flow Blinker indicator to show when the regulator is functioning.

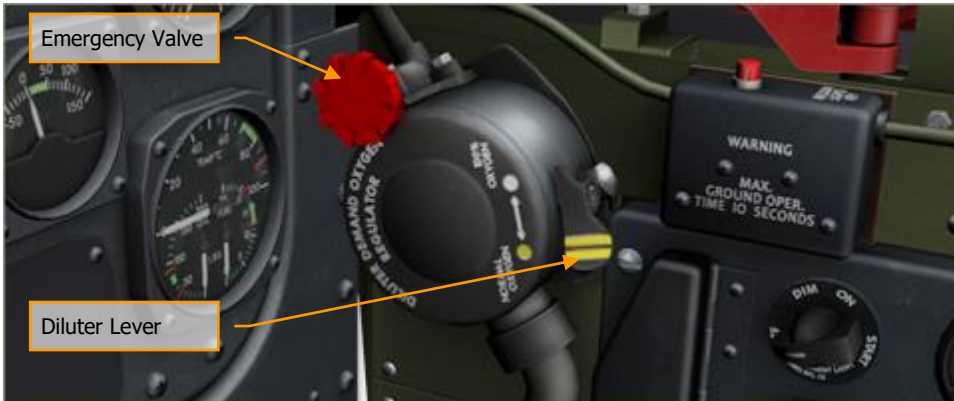

**Figure 72: Oxygen Regulator**

**DILUTER LEVER.** The Diluter lever is located on the side of the regulator case and may be positioned to NORMAL OXYGEN or 100% OXYGEN. The Diluter lever manually operates the air shutoff valve, allowing the regulator to deliver pure oxygen when the lever is in the 100% OXYGEN position. During normal operations, the Diluter lever should be left in the NORMAL OXYGEN position to allow air and oxygen to mix in the proper proportions for any given altitude.

**EMERGENCY VALVE.** The regulator has an independent oxygen emergency valve. When the valve is turned counterclockwise, a continuous stream of oxygen is allowed to by-pass the regulator and flow to the mask.

## Recognition Lights

The P-51D is equipped with three recognition lights - red, green, and amber, installed underneath the right wing. Each light is provided a switch on the Electrical Control panel and can be set to burn continuously or be flashed on and off by means of a keying switch mounted in a box just above the Electrical Control panel.

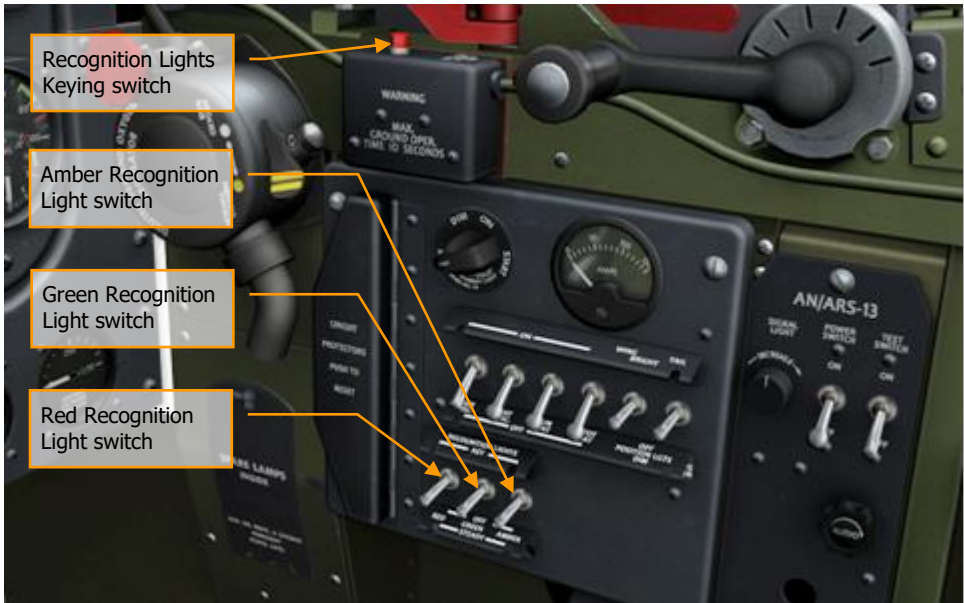

**Figure 73: Recognition Lights**

**RECOGNITION LIGHTS KEYING SWITCH.** The keying switch is used to turn the recognition lights on and off when the lights are set to KEY on the Electrical Control panel.

**RECOGNITION LIGHT SWITCHES.** The Red, Green, and Amber Recognition Light switches have three possible positions: OFF, STEADY, and KEY. When set to STEADY, the light burns continuously. When set to KEY, the light turns on and off with each press and release of the keying switch. When set to OFF, the light stays off.

**Do not operate the recognition lights for over 10 seconds continuously on the ground. This may result in melting the plastic lens due to heat.**

## Electrical Control Panel

The Electrical Control panel is located on the right side of the cockpit and includes the Circuit Breaker panel, Right-hand Fluorescent Light Rheostat switch, Ammeter, and a number of additional systems control switches.

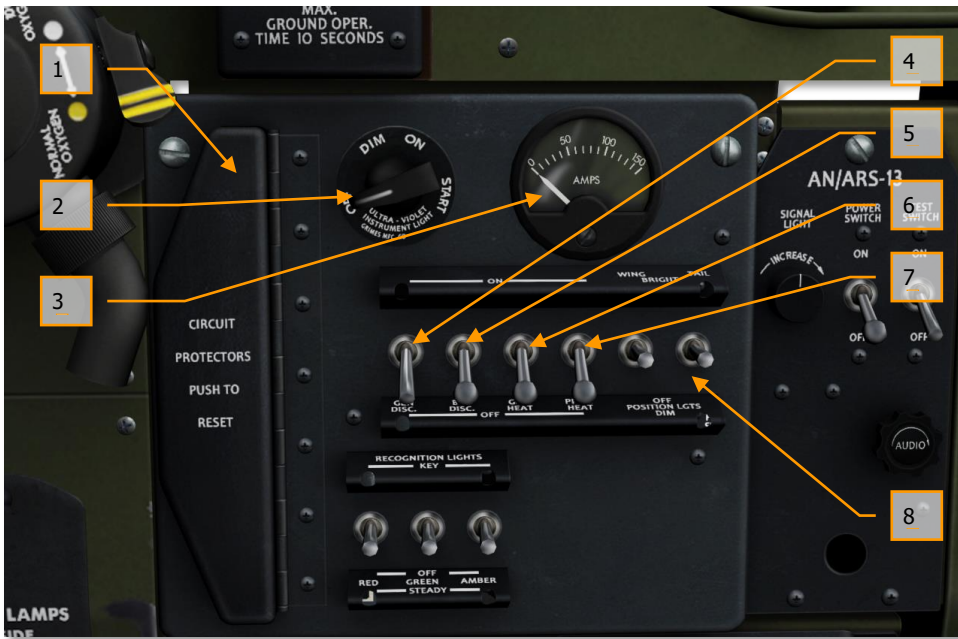

**Figure 74: Electrical Control Panel**

- 1. CIRCUIT BREAKER PANEL.** A row of circuit breakers is provided on the Circuit Breaker panel. Each circuit is designed to pop out if it is overloaded and can be reset by pushing it back in. A master "bump" plate covers the panel to allow the pilot to reset all of the circuit breakers with one press of the bump plate.
- 2. RIGHT-HAND FLUORESCENT LIGHT RHEOSTAT.** This rheostat controls the right fluorescent instrument panel light. To turn the light on, first set the switch to the START position, then adjust intensity between the ON and DIM settings. Note, the left fluorescent light is controlled by the Left-hand Fluorescent Light rheostat located on the [Radiator Air Control panel](#).
- 3. AMMETER.** The Ammeter gauge indicates the amount of current being supplied by the generator. The gauge is graduated from 0 to 150 amperes and scaled to 10 amperes. Normal maximum current is 100 amperes and should only be used for a short period of time. Takeoff should not be performed if a reading of over 50 amperes is present.
- 4. GENERATOR DISCONNECT SWITCH.** The Generator Disconnect switch has two positions: ON and OFF. When set to ON, the generator provides power to the electrical system when the speed is above approximately 1200 RPM. When set to OFF, generator power is not provided. All electrical equipment on the aircraft is powered by the generator, except the Remote-Indicator Compass, which derives power from the inverter.

**5. BATTERY DISCONNECT SWITCH.** The Battery switch has two positions: ON and OFF. When set to ON, battery power is supplied to the electrical system. When set to OFF, battery power is not provided. The switch should be set to OFF when external power is used for starting, to conserve the battery. Whenever the engine is running and external power is disconnected, the switch should be set in the ON position.

**6. GUN HEAT SWITCH.** The Gun Heat switch is used to enable or disable power to the electrical heaters installed on the cover plate of each gun. Gun Heat should remain on whenever flight conditions necessitate.

**7. PITOT HEAT SWITCH.** The Pitot Heat switch is used to enable or disable power to the electrical heater of the pitot tube. Pitot heat should remain on whenever flight conditions necessitate. Pitot heat should be set to OFF on the ground, as not enough air flow is present to cool the heater and prevent overheating.

**8. POSITION LIGHTS.** The Wing and Tail Position Lights switches control the position lights located on the wing and tail of the aircraft. Each switch has three possible positions: OFF, DIM, and BRIGHT.

## AN/APS-13 Rear Warning Radar

The AN/APS-13 rear warning radar is a lightweight radar set that provides a cockpit warning when an aircraft is approaching from the rear. The warning indicator light is mounted above the front dash on the left side and the bell alarm is mounted on the side cockpit wall near the seat.

The AN/APS-13 control panel includes a Power switch, Test switch, warning light intensity rheostat, and a volume knob for the VHF set.

When flying at low altitudes, the warning radar may sound an alarm due to signal reflections from the ground.

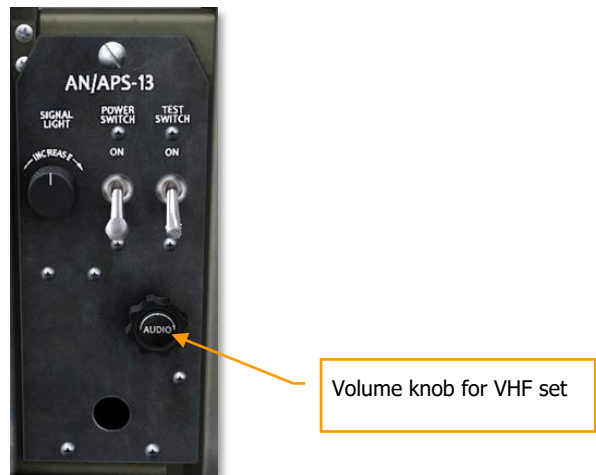

**Figure 75: AN/APS-13 Rear Warning Radar**

## SCR-522-A VHF Radio

The SCR-522-A command radio is a push-button controlled transmitter-receiver that operates in the 100 - 156 MHz band and is used for radio homing and two-way voice communication. The control box is located just aft of the Electrical Control panel on the right side of the cockpit. A microphone button is located on the throttle handle. The radio operates on one of four preset frequency channels. The frequency of each channel is set in the mission editor by the mission designer and cannot be changed in flight. The desired channel is selected in flight by the pilot using the Channel Selector buttons. A Mode switch is provided that allows the pilot to select remote operation (REM) using the throttle Mic button, continuous reception (R), or continuous transmission (T).

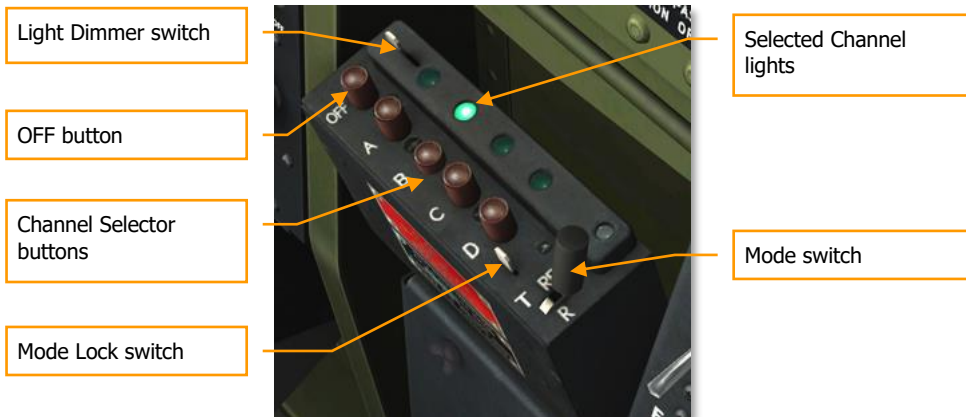

**Figure 76: SCR-522-A VHF Radio**

**LIGHT DIMMER SWITCH.** The Light Dimmer switch is used to cover the Selected Channel lights with a dimmer cap to minimize light glare in the cockpit.

**OFF BUTTON.** When pressed down, the OFF button disables the radio.

**CHANNEL SELECTOR BUTTONS.** The Channel Selector buttons are used to set the channel for reception and transmission. Only one channel can be selected at a time.

- "A" channel is usually used for all normal plane-to-plane communication or for plane-to-ground communication with a Controller.
- "B" channel is common to all VHF-equipped control towers. It is normally used to contact the control tower for takeoff and landing instructions.
- "C" channel is frequently used in contacting homing stations.
- "D" channel is normally used for plane-to-ground contact with D/F stations, and as a special frequency which is automatically selected at regular intervals by the action of a contactor unit.



**SELECTED CHANNEL LIGHTS.** The Selected Channel lights indicate when a channel is selected for reception and transmission.

**MODE LOCK SWITCH.** The Mode Lock switch is used to lock the Mode switch in the selected position. When the Mode Lock switch is set to the up position, the Mode switch is held in place by a locking mechanism. When the Mode Lock switch is set to the down position, the Mode switch is held in the R (receive) position and can be moved to a spring-loaded T (transmit) position to allow the pilot to transmit in case remote operation of the transmitter using the Mic button is inoperable. When released from the T position, the Mode switch reverts to the R position for continuous reception. The Mode switch cannot be set to the REM (remote) position when the Mode Lock switch is set in the down position.

**MODE SWITCH.** The Mode switch has three possible positions: REM (remote), R (receive), and T (transmit). When set to REM, the radio is operated by the throttle Mic button, receiving when the Mic button is released and transmitting when it is pressed. When set to R, the radio is in continuous reception mode. When set to T, the radio is in continuous transmit mode.

You control the volume of the VHF set by means of a knob on the AN/APS-13 Rear Warning Radar control panel located at your right side.

## SCR-695-A IFF Radio

The SCR-695-A IFF (Identification Friend or Foe) radio set permits automatic transmission of identification signals upon reception of a challenge signal from a properly equipped friendly air or surface unit. It can also be used to transmit emergency or distress signals. The IFF controls include a Code Selector switch which provides a choice of six code settings, an Emergency switch for transmitting a distress signal, and an ON-OFF control switch.

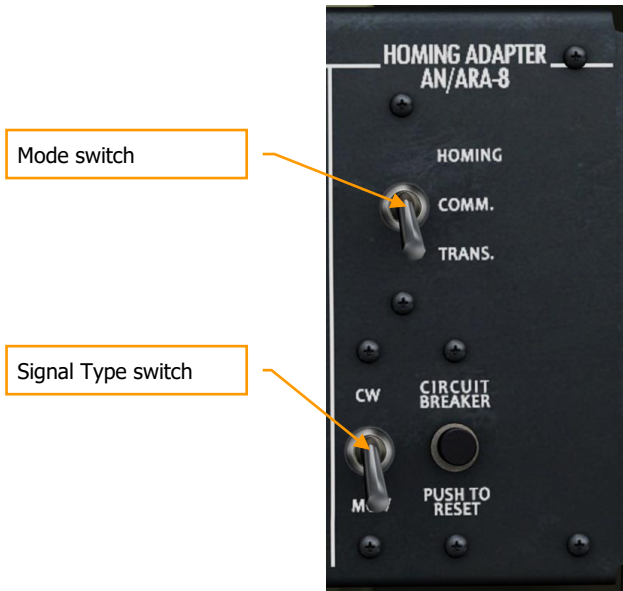

**Figure 77: SCR-695-A IFF Radio**

The SCR-695-A IFF Radio is not operational in DCS: P-51D Mustang.

## AN/ARA-8 Homing Adapter

The AN/ARA-8 Homing Adapter unit is used in conjunction with the SCR-522-A command radio to permit homing on any transmitting carrier within the frequency range of 120 - 140 MHz. In addition, this equipment may be used for air-to-air homing for the purposes of rendezvous. Homing can be performed on continuous wave (CW) and modulated continuous wave (MCW) signals. Homing signals are provided to the pilot in the form of an audible signal in the headset, Morse code character D (– •) when the transmitting station is to the left and Morse code character U (• • –) when the transmitting station is to the right.



**Figure 78: AN/ARA-8 Homing Adapter**

**MODE SWITCH.** The Mode switch is used to set the operating mode of the adapter. When set to HOMING, the adapter is in Homing mode and homing audio signals are provided to the pilot through the headset. In this mode, no voice communication is heard from the VHF radio. When set to COMM., the adapter is not homing and voice communication from the VHF radio is provided to the pilot's headset. When set to TRANS., the adapter transmits a signal using the radio to act as a beacon for other aircraft.

**SIGNAL TYPE SWITCH.** The Signal Type switch is used to set the signal type for homing - Continuous Wave (CW) or Modulated Continuous Wave (MCW).

The AN/ARA-8 Homing Adapter is not operational in DCS: P-51D Mustang.

## BC-1206 "Detrola" Radio Range Receiver

Because the SCR-522-A radio command set installed in the aircraft is of the Very High Frequency type, the BC-1206 "Detrola" radio range receiver is used for reception of signals in the Low Frequency range of 200 - 400 kHz. The Detrola is located toward the bottom of the right side of the cockpit, forward of the seat. The Detrola is a receiver only and does not transmit. However, reception is possible using both the Detrola and the VHF command radio simultaneously. Controls of the Detrola include the ON-OFF/Volume knob and the Tuning knob.

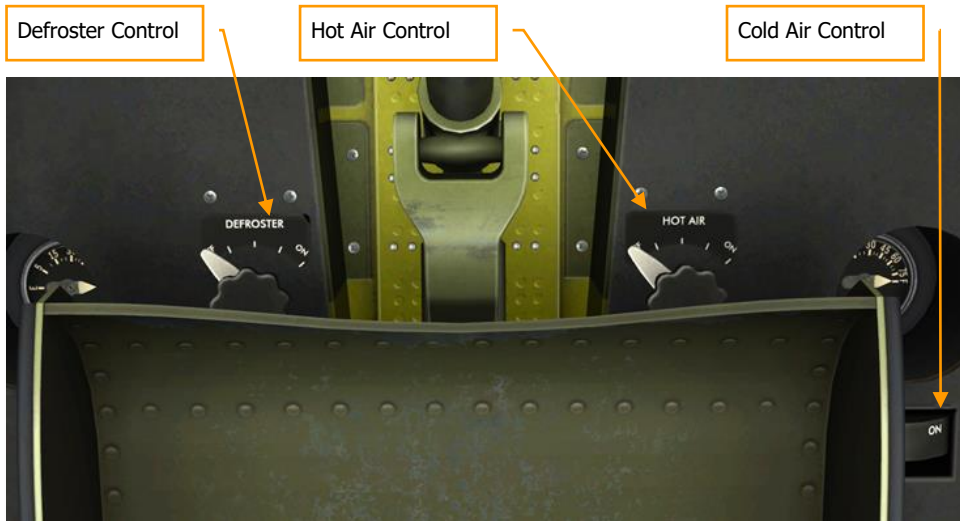

**Figure 79: BC-1206 "Detrola" Radio Range Receiver**

The Detrola is not operational in DCS: P-51D Mustang.

## Cockpit Heating and Ventilating Controls

The P-51D is equipped to provide hot and cold air into the cockpit, as well as defrosting air for the windshield.



**Figure 80: Cockpit Heating and Ventilating Controls**

**DEFROSTING CONTROL KNOB.** The windshield Defrosting Control knob is located on the floor of the cockpit, on the left side below the seat. The control may be set to ON, OFF, or any intermediate position and mechanically controls a gate valve in the air duct.

**HOT AIR CONTROL KNOB.** The cockpit Hot Air Control knob mechanically controls a gate-type valve and is located on the floor of the pilot's cockpit, below the right front edge of the seat. The control may be set to ON, OFF, or any intermediate position and mechanically controls a gate valve in the air duct.

**COLD AIR CONTROL HANDLE.** The Cold Air Control handle is located at the right side of the pilot's seat on the cockpit floor. The handle has two possible positions: ON and OFF. Operation of the control handle mechanically allows a flow of cold air from the two outlets located behind the pilot's seat.

## Kneeboard Map

To aid with navigation, a kneeboard map is included in the cockpit. The map can be opened at any time in the cockpit for a quick glance by pressing and holding the [K] command or toggled on and off with the [RSHIFT + K] command. The map displays a plot of the flight plan and is initially centered on the starting waypoint. The [ ] (open bracket) and [ ] (close bracket) commands can be used to change the kneeboard page, which cycles through the flight plan waypoints on the map view.

Additionally, the [CTRL + K] command can be used to place a mark point on the map. A mark point indicates the location of the aircraft on the map, the aircraft's heading, and the game time at which the mark point was placed.

The kneeboard can also be viewed on the pilot's left leg when the pilot is enabled in the cockpit ([RSHIFT + P]).



Figure 81: Kneeboard Map

# FLIGHT CHARACTERISTICS



# FLIGHT CHARACTERISTICS

## General Characteristics

The P-51D is generally a very well-handling aircraft. It is very light on all of the controls and stable at all normal loadings. Light, steady pressure on the controls is sufficient to execute any routine maneuver. At various speeds in level flight or in climbing or diving, the control pressures required are slight and can be stabilized by adjustments on the trim tabs. However, the trim control tabs themselves are sensitive and require careful adjustments. The rudder and the elevator trim change slightly as the speed or the power output of the engine changes.

The aircraft has a redline speed of 505 mph Indicated Airspeed (IAS), with a maximum diving engine RPM of 3240. Extra caution should be used not to attempt steep dives at low altitudes as the aircraft accelerates very rapidly.

The aircraft is susceptible to high speed stalls, but not any more so than any other high speed aircraft. A buffeting of the tail section occurs about 5 to 10 MPH above the stall. All that is necessary to recover from a high speed stall is to release the back pressure on the stick and then recovery is almost instantaneous.

Recovery from a normal stall is the same. The buffeting, however, occurs at about 3 to 5 miles per hour above the stall.

The aircraft is generally normal in its flying characteristics. When trimmed for normal cruising speed, the aircraft will become nose-heavy when the nose is raised and the airspeed drops. Under the same cruising conditions, if the nose is lowered and the airspeed increases, the aircraft will become tail heavy in direct proportion to the airspeed.

When you lower the flaps, the airplane becomes nose heavy.

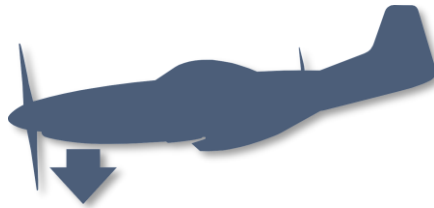

When you raise the flaps, the airplane becomes tail heavy.

When you retract the landing gear, the airplane becomes tail heavy.

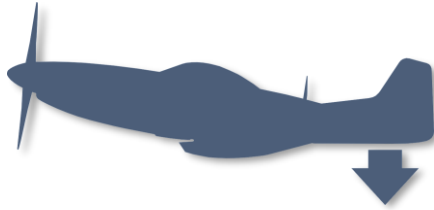

When you lower the landing gear, the airplane becomes nose heavy.

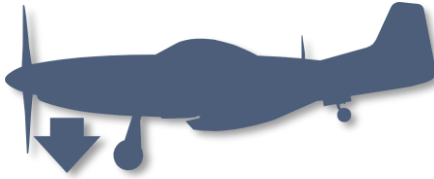

Similarly, normal flight attitude changes can be expected when raising or lowering the flaps and landing gear. Increased drag causes the aircraft to lower the nose, while decreased drag results in raising the nose.

The P-51 does not hold a sustained side-slip. The aileron control is not sufficient to hold the aircraft in a side-slipping angle. However, side-slip can be maintained for a short duration of time in an effort to evade enemy fire. When any side-slipping is attempted, complete recovery should be achieved above 200 feet to avoid ground collision.

As new equipment was added to the aircraft over the course of its development, in particular the radio equipment and the fuselage tank installed aft of the cockpit, the center of gravity (CG) has been moved back. This has resulted in decreased back pressure required to move the control stick. Instead of a force of 6 lbs. per G of acceleration, the required force in the P-51D is only 1 ½ lbs. Additionally, the stick forces begin to reverse as acceleration exceeds 4G. Great care must be taken not to black out or over-stress the airframe in sharp pulls and turns.

## Operating Limits

### Load Factor Limitations

The P-51D structural load limit is +8G and -4G (plus a standard safety factor of 1.5). The below chart illustrates the maximum load factor limitations for different indicated airspeeds and three altitude bands at a gross weight (GW) of 9,000 lbs.

To calculate the maximum G load for a different GW, take the maximum load for the desired airspeed and altitude band provided in the chart, multiply by 9,000 and divide by the desired GW. For example, to calculate the maximum G load for a GW of 11,000 lbs (i.e. a P-51D with payload) at 225 mph IAS and altitudes below 10,000 feet, perform the following steps:



- Take the maximum G load provided by the chart for 225 mph IAS at altitudes below 10,000 feet (4G)
- Multiply the chart reading by 9,000 ( $4 \times 9,000 = 36,000$ )
- Divide the result by desired GW ( $36,000 / 11,000 = 3.27G$ )

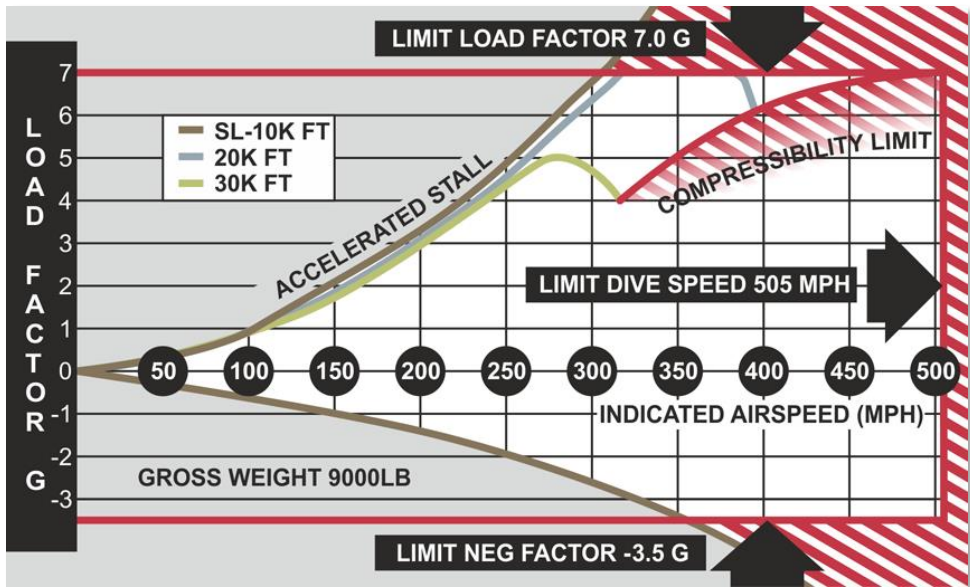

Figure 82: Load Factor Limitations

**Aerobatics are NOT permitted unless the fuselage tank contains less than 40 gallons of fuel or if external fuel tanks and/or bombs are carried.**

## Engine Limitations

The maximum diving engine overspeed is 3240 RPM. Avoid operation below 1600 RPM in low blower supercharger mode. Avoid operation below 2000 RPM in high blower supercharger mode.

## Airspeed Limitations

The red line index on the Airspeed Indicator marks the maximum permissible airspeed (505 mph) up to 5,000 feet in altitude. At altitudes above 5,000 feet, the maximum permissible indicated airspeed must be adjusted for altitude as indicated in the [Maximum Indicated Airspeed](#) illustration.

Do not exceed the following wing flap setting airspeed restrictions:

Flaps Down Angle [degrees]	Maximum IAS [mph]
10	400
20	275
30	225
40	180
50	165

When droppable 75-gallon combat fuel tanks are installed, do not exceed 400 mph indicated airspeed. Do not allow airspeed to fall below 110 mph indicated airspeed during a sideslip.

## Instrument Markings

Flight and engine operating limits for normal flight are included on the cockpit on a special placard and consist of the following limits:



**Figure 83: Max. takeoff manifold pressure – 61 in. HG (155 cm HG) (red mark). Operating range 26...36 in. HG (66.04 - 91.44 cm HG) (green zone).**



**Figure 84:**

**Max permissible oil temperature 90°C (194°F), operating oil temperature 70...80°C (158...176°F).**

**Max permissible oil pressure 90 lbs./sq. in. Min permissible oil pressure 50 lbs./sq. in. Operating oil pressure range 70...80 lbs./sq. in.**

**Max fuel pressure 19 lbs./sq. in. Min permissible fuel pressure 12 lbs./sq. in. Operating fuel pressure range 12...16 lbs./sq. in.**



Figure 85: Max. take-off RPM 3000. Operating Range 1600...2400.



Figure 86: Max. permissible IAS 505 mph (808 km/h, 440 knots)



Figure 87: Max. coolant temperature 121°C (250°F), operating range 100...110°C (212...230°F)



Figure 88: Desirable carburetor air temperature range 15...30°C (59...86°F), maximum 40°C (104°F)

## Special Flight Conditions

### Full Fuselage Tank

Special care must be taken with the control stick when the fuselage tank contains more than 25 gallons of gas. In such cases, the flying characteristics of the aircraft change considerably – increasingly so as the amount of fuel in the tank is increased. When carrying more than 40 gallons of fuel in the fuselage tank, it's necessary to avoid any high performance maneuvers. The fuel weight shifts the CG back, making the aircraft highly unstable during maneuvering.

### Reversibility

With the fuselage tank full, the CG of the aircraft moves back so far that it is nearly impossible to trim for hands-off level flight. Also, as soon as a sharp pull or turn is attempted, the stick forces reverse due to the effects of high G on an aft-positioned CG airframe. For example, once the G is loaded into a turn, the aircraft will naturally tighten the pull and may require pushing *forward* on the stick to balance. Similarly, when recovering from a dive with an aft-positioned CG, the aircraft tends to recover too sharply and may require changing from pulling the stick back to pushing it *forward* to maintain a desirable pullout rate.

The tendency for the CG to affect stick forces to the point of reversing them is called Reversibility. In the P-51, this effect can be expected when the fuselage tank is loaded with a significant quantity of fuel. Reversibility is reduced rapidly as the fuel quantity in the fuselage tank drops to half and below. Additionally, the P-51D features a bobweight added to the elevator control system bellcrank. This weight reduces the amount of forward pressure required to overcome reversibility tendencies.

### Drop Tanks

When equipped with drop tanks, only normal flight attitudes are permitted. Only normal climbing turns and descents should be performed when carrying drop tanks.

### Low Level Flight

When flying at extremely low altitudes, the aircraft should be trimmed slightly tail-heavy to avoid dropping the nose toward the ground in case the pilot's attention is momentarily taken away from aircraft control.

### High Altitude Flight Characteristics

The P-51D's 2-stage, 2-speed supercharger provides plentiful power up to well above 35,000 feet. As a general rule, the greater the altitude, the greater the control movement required to achieve the same response.

The supercharger blower will automatically shift into high speed at between 14,500 and 19,500 feet. This change will be accompanied by a momentary surge in power and increase in manifold pressure, until the manifold pressure regulator catches up. There is no noticeable effect when the supercharger

shifts back into low blower on the descent. As a precaution, attention should be paid to the Supercharger control switch. If the amber light isn't out below 12,000 feet, the supercharger should be set manually to LOW. When running in high blower, care should be taken to handle the throttle smoothly, as any rough handling will cause the engine to surge, greatly decreasing the efficiency of the airframe at high altitude and increasing control efforts.

## High Speed Dives

The P-51 is an excellent diving platform, thanks to its clean-lined design, laminar-flow wing, exceptional aerodynamics characteristics, and small frontal area. It is capable of developing terrific speeds, which makes it necessary to pay careful attention when diving. The following table illustrates safe pullout altitudes for various diving angles. These figures are based on a constant 4G pull for a flight level altitude of 4,000 feet at recovery.

It is recommended that trim tabs are not used during a dive after the aircraft is trimmed for level prior to initiating the dive. If so desired, the aircraft can be trimmed once during the dive, but this must be done carefully as the trim tabs are sensitive to input and care must be taken not to trim the aircraft nose-heavy.

**Note the accompanying table, which shows the minimum safe altitude required for pullout from dives of various degrees. These figures are based on a constant 4G acceleration, which is about what the average pilot can withstand without blacking out.**

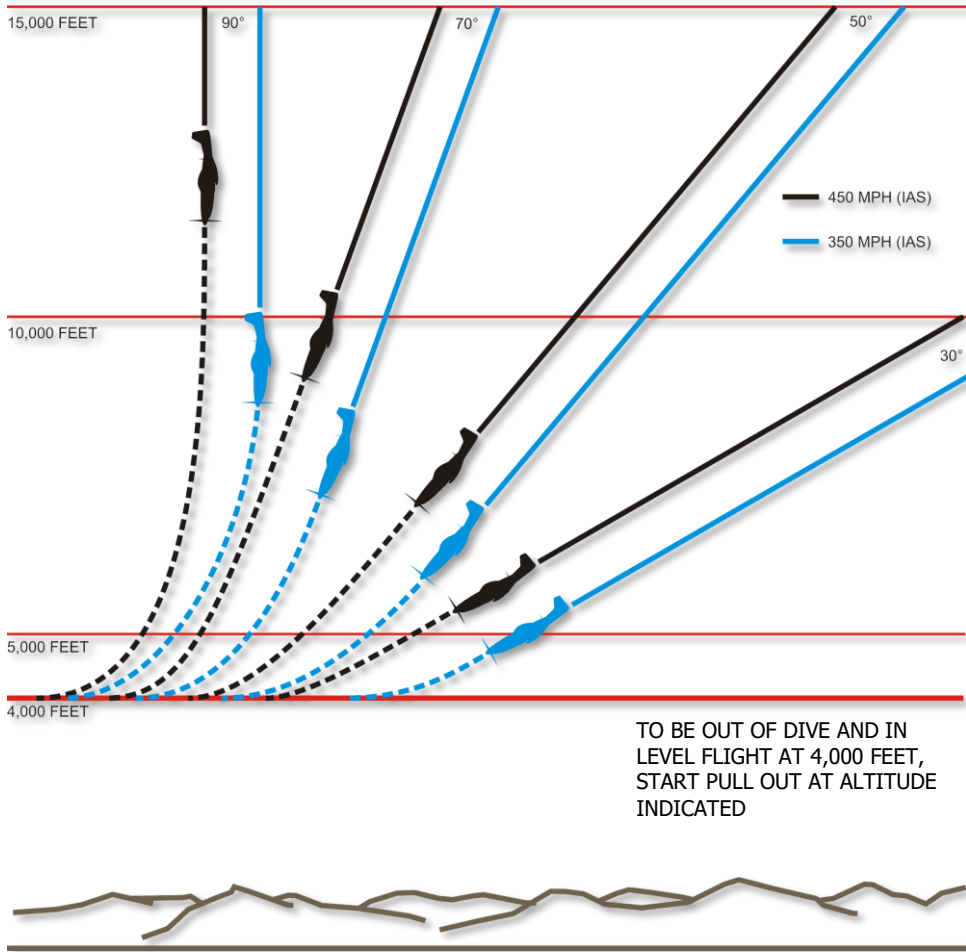

**Figure 89: Minimum Safe Altitude**

## Maximum Indicated Airspeed

The maximum safe indicated airspeeds (IAS) for the P-51 at different altitudes are provided in the graph below. Note that at altitudes above 5,000 feet the figures are *less* than 505 mph IAS. In other words, the red line speed for the P-51 is not a fixed figure, but a variable figure with altitude. The greater the altitude, the lower the maximum allowable IAS. Reaching speeds greater than the allowed maximums will overstress the wings and other structural elements of the airframe.



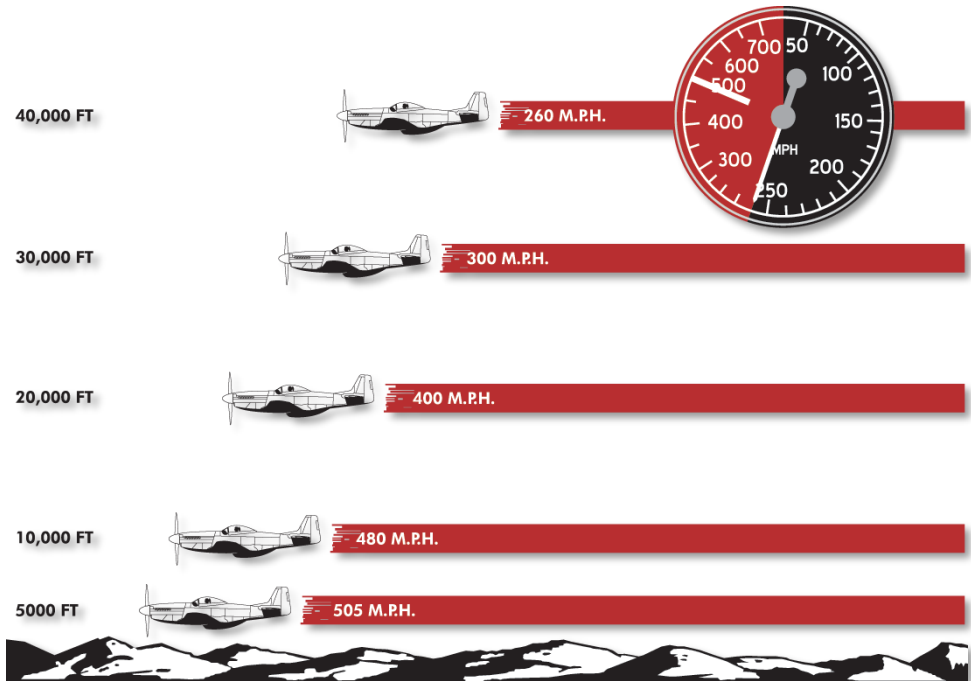

Figure 90: Maximum Indicated Airspeed

## Compressibility

Compressibility effects result in a loss of control over the aircraft as it approaches the speed of sound and is the reason maximum IAS is reduced as altitude increases. The lift characteristics of the aircraft are largely destroyed and intense drag develops. The stability, control, and trim characteristics of the aircraft are affected. The tail buffets or the controls stiffen, or the aircraft develops uncontrollable pitching and porpoising, or uncontrollable rolling and yawing, or any combination of these effects. If the speed of the aircraft is allowed to increase out of control in a dive, either the terrific vibrations of the sound barrier shockwaves cause structural failure or the aircraft crashes while still in the compressibility dive.

In the P-51, the first effect of compressibility is a "nibbling" of the control stick, where it occasionally jumps slightly in the pilot's hand. If the airspeed is allowed to climb, this movement will increase into a "walking" stick, where it moves uncontrollably forward and back, resulting in the characteristic "porpoising" pitching moments of the aircraft. As the airspeed builds, this effect will become increasingly violent.

To avoid compressibility effects in a dive, it's critical that a dive is entered at a safe airspeed for the altitude and that airspeed is monitored carefully during the dive. The table below indicates safe dive start airspeeds for different altitudes in both True Airspeed (TAS) and Indicated Airspeed (IAS).

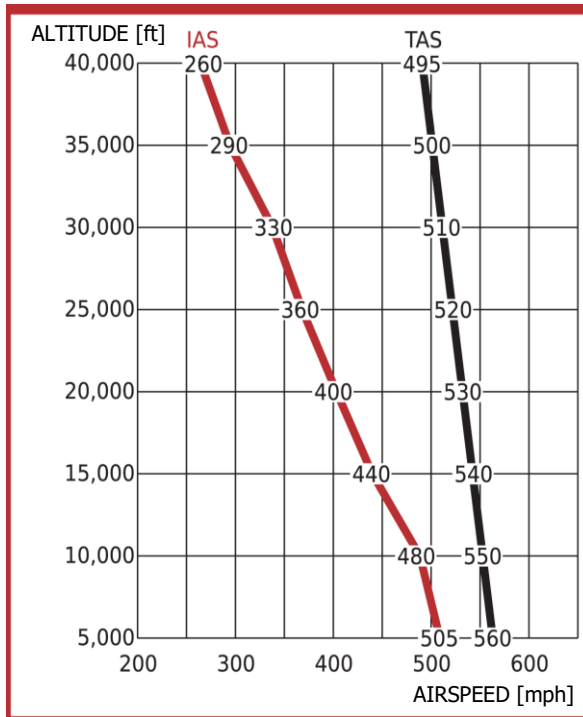

**Figure 91: Maximum Allowable Diving Speeds**

## Glides

The P-51 can be glided safely at speeds down to 25% above stalling speed. With average loads, this will be around 125 mph IAS at any level – this speed increasing with the weight of the aircraft. The optimum power-off gliding speed is 175 mph.

With the landing gear and flap retracted, the glide flight path is fairly flat. In this condition, however, the nose is held high and forward visibility is poor. Lowering either the flaps or the landing gear reduces the safe gliding speed and greatly steepens the gliding angle and increases the rate of descent.

The table below demonstrates the horizontal glide distances obtained with a power-off glide at 175 mph IAS from various altitudes:

Alt. [ft]	40,000	35,000	30,000	25,000	20,000	15,000	10,000	5,000
Dist. [mi]	115	101	87	72	58	43	29	14

## Stalls

A stall occurs when the aircraft is unable to generate sufficient lift for controlled flight, usually on one of both wings. This results in a loss of control to various degrees, leading to a possible wing-over or an uncontrolled spin in the worst case. The P-51 stalling characteristics are generally mild and recoverable. In general, a stall is preceded by airframe buffeting. Stalling speeds vary greatly depending on the gross weight and the external loading of the aircraft. Lowering the flaps reduces stall speeds considerably.

Recovery from a stall on the P-51 is normal. In early onset, simply releasing the stick and rudder to drop the nose will recover control. If a wing-drop condition occurs, applying opposite rudder and releasing the stick will recover control.

The below chart illustrates the approximate indicated power-off stall speeds in mph for various flight conditions:

	Gross weight [lbs]	Gear up Flaps up			Gear down Flaps 45° down		
		Level	30° bank	45° bank	Level	30° bank	45° bank
With Wing Racks Only	10,000	106	115	128	101	110	123
	9,000	101	109	121	94	103	116
	8,000	94	102	114	87	98	108
With Bombs, Drop Tanks, or Rockets	12,000	119	128	143	113	123	136
	11,000	113	122	137	107	117	131
	10,000	108	116	130	102	111	124
	9,000	102	110	123	95	105	117

## Spins

### Power-off Spins

In general, spins in the P-51D are uncomfortable, because of heavy oscillations. Occasionally, the left spin oscillations will dampen out after approximately three turns, but the right spin oscillations will not. When controls are applied to start a spin, the aircraft snaps one-half turn in the direction of the spin, with the nose dropping to near vertical. At the end of one turn, the nose rises to or above the horizon and the spin slows down, occasionally coming almost to a complete stop. The aircraft then snaps one-half turn with the nose dropping to 50-60 degrees below the horizon and continues as during the first turn. The force required to hold the controls in the spinning position is quite heavy, and some rudder buffet becomes noticeable. When controls are applied for recovery, the nose drops to a near vertical position and the spin speeds up and then stops in one to 1 and 1/4 turns.

### Power-off Spin Recovery

Recovery procedure is the same in both a left and a right spin. As soon as opposite rudder is applied, the nose drops slightly. The spin speeds up for about 1 and 1/4 turns and then stops. The rudder force is light at first, becomes very heavy for about one second in the first one-half turn, and then drops to zero as the spin stops. Recovery is affected in the normal manner as follows:

- Controls with spin.
- Apply full opposite rudder.
- Stick neutral after the aircraft responds to rudder (as rotation stops).
- Rudder to neutral and complete recovery as spin ends.

### Power-on Spins

Power-on spins should never be intentionally performed in the P-51. In a power-on spin, the nose of the aircraft remains 10 to 20 degrees above the horizon, and recovery control has no effect upon the aircraft until the throttle is completely retarded.

### Power-on Spin Recovery

Close throttle completely and apply controls as for power-off spins recovery. Hold full opposite rudder with stick in neutral until recovery is affected. As many as five or six turns are made after rudder is applied for recovery, and 9,000 to 10,000 feet of altitude are lost.

## High Performance Maneuvers

The P-51D offers exceptional aerobatic qualities; stick and rudder pressures are light and the aileron control is excellent at all speeds. The primary safety consideration for any high performance maneuver is altitude.

The aircraft is capable of performing chandelles, wingovers, slow rolls, loops, Immelmans, and Split S turns with ease. However, remember that inverted flight must be limited to 10 seconds, because of loss of oil pressure and failure of the scavenger pump to operate in an inverted position.

When performing a loop, the nose of the aircraft needs to be pulled over the top, as it may not do so by itself. Without pulling pressure on the stick, the aircraft has a tendency to climb on its back.

The aerodynamic characteristics of the P-51D are such that snap rolls cannot be satisfactorily performed. Attempting to snap roll the aircraft aggressively may result in a power spin.

**High performance maneuvers can only be performed when the fuselage tank contains less than 40 gallons of fuel.**

## Instrument Flying

### Altitude Control

The rate of climb or descent, at a given airspeed and power setting, is determined by the degree of pitch, or nose attitude change. At high speeds, a very slight change in pitch will immediately result in a high rate of climb or descent, with a rapid gain or loss of altitude. Therefore, when maneuvering at low altitude under instrument conditions, as during an instrument approach, the primary rule of safety is: *keep the airspeed down.*

### Bank Control

The turn needle is gyro-actuated and indicates rate of turn only, regardless of speed. Therefore, at a given rate of turn, the angle of bank in a coordinated turn depends upon true airspeed. A standard-rate turn at an altitude of 1,000 ft and an IAS of 200 MPH will require approximately 27° of bank. But at 25,000 ft, an IAS of 200 MPH will require about 37° of bank to accomplish a standard-rate turn, because the TAS at that altitude is in excess of 300 MPH.

Control pressure on the elevators changes rapidly during the entry into a steeply banked turn, and it's very easy at this time to make inadvertent changes in your pitch. As explained above, these slight changes in nose attitude, at high speeds, will result in large altitude variations; these can be critically dangerous when flying on instruments and close to the ground. This hazard can also be avoided by keeping the airspeed low. When airspeed is low, the angle of bank required for a given rate of turn is greatly lessened and the problem of control is proportionally reduced.

### Control Sensitivity

Given the sensitivity of the P-51 controls, it is essential to remain mentally attentive to the instruments at all times. Accurate trim control is extremely important; it will contribute greatly to physical relaxation and make it easier to concentrate on the numerous unrelated details of instrument flight. Trimming should be done carefully and as often as required.

### Instrument Approach

Shortly before reaching the station on the initial approach, airspeed is reduced to 150 mph Indicated and flaps are lowered to 10°. Keeping the airspeed low simplifies radio procedures and increases control of the aircraft.

After completion of the initial approach, final approach is performed at 130 mph Indicated, with landing gear down and flaps set to 15°.

Although final approach speed depends largely on ceiling conditions, 130 mph with 15° of flaps is recommended.

## Icing

Ice normally forms on the windshield, wing, stabilizer, vertical fin, and forward portions of the drop tanks. At first sign of icing, change altitude immediately to get out of the icing air layer. Ice accumulation increases drag and decreases lift, requiring an increase in power to maintain altitude and airspeed. If ice accumulates on the wings, make wide, shallow turns at a greater airspeed than normal, especially during approach and landing. Use flaps with care. Remember, stalling speed increases with ice. Be sure the pitot heater is on during icing conditions.

Ice can also form in the intake duct and affect engine performance. Carburetor ice forms most readily when carburetor air temperature is between -10°C (14°F) and +15°C (59°F). However, carburetor ice can form at any time, even with outside temperature as high as 32°C (90°F) and with temperature and dew point spread as much as 12°C (54°F). The formation of carburetor ice is hard to detect, because the automatic manifold pressure regulator maintains a constant manifold pressure. The only warning is a roughness of the engine.

To prevent carburetor icing, set the carburetor Ram Air control lever to UNRAMMED FILTERED AIR and the Hot Air control lever to HOT AIR. Use the two controls together. If application of carburetor hot air does not remove roughness, clean out the engine by running it at full Takeoff Power for one minute. If carburetor ice is the cause of roughness, use hot air as needed to prevent further ice formation.

If the air duct becomes obstructed with ice, hot air is automatically admitted to the intake regardless of the position of the carburetor air control.

# NORMAL PROCEDURES

BLADE SERIAL NO. APS17233  
BLADE ASSEM. 156-22481  
LOW ANGLE 42 IN. RAD. 22.8  
HIGH ANGLE 42 IN. RAD. 57.8

REMOVE BEFORE

ING GEAR  
SPECTION

# NORMAL PROCEDURES

## External Check

The external check starts at the cockpit and moves clockwise around the left wing, engine, right wing and finally the tail section. In walking to the aircraft and going around it, check the entire airframe for wrinkles, loose rivets, dents, and loose access doors. Pay special attention to the following points:

- Check the tires. See that they are properly inflated, especially that they are not too low and not worn deeply in spots.
- Check the clearance of the landing gear struts. The clearance should be about  $3 \frac{7}{16}$  inches and equal on both struts.
- Check the pitot tube to make sure the cover is removed.
- Make sure the covers on the gun hatches are securely fastened.
- Check the caps on the gas tanks, making sure they are properly closed.
- In looking over the aircraft, check all of Dzus fasteners, especially those around the nose section. Also, be sure to check the screws in the fairings, especially those between the wing and fuselage.

## Pre-start

As soon as you enter the cockpit, make sure that the ignition switch is OFF and the mixture control is at IDLE CUT-OFF. Perform the following check around the cockpit, working from left to right:

- Fuselage fuel – check the gauge on top of the fuselage tank (behind the pilot's seat, left side).



- Flap handle – UP.
- Carburetor ram air control – forward in RAM AIR position (unless FILTERED AIR required).
- Carburetor hot air control – forward to NORMAL position (unless HOT AIR required).



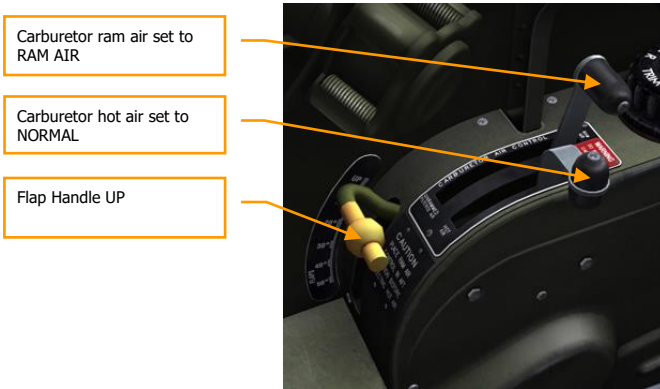

- Trim tabs
  - Rudder trim: 6° right.
  - Aileron trim: 0°.
  - Elevator trim: 0° if fuselage tank is filled with less than 25 gallons of fuel; 2 - 4° nose heavy if the fuselage tank is filled with more than 25 gallons of fuel.

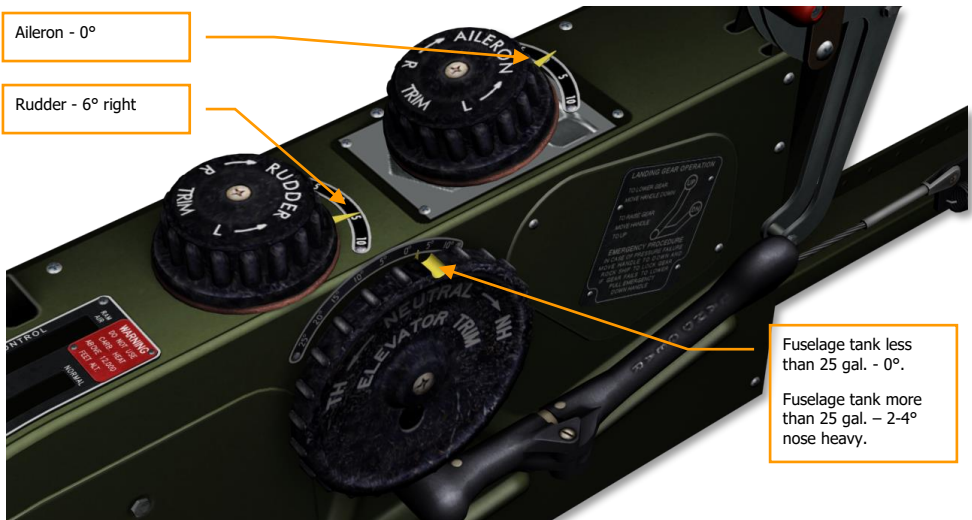

- Landing gear handle – DOWN.

Landing gear  
handle DOWN

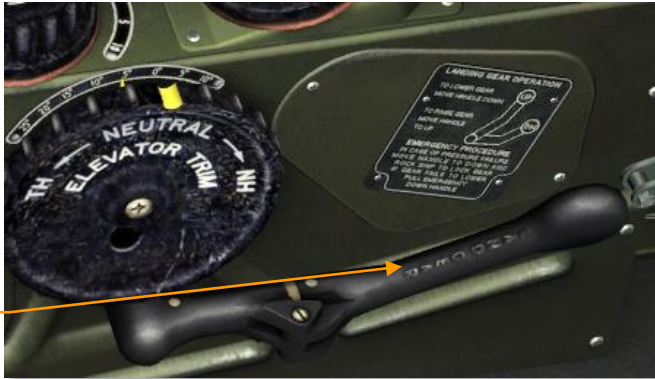

- Left fuel gauge – check gauge, located on floor at your left.



- Mixture control – IDLE CUTOFF.
- Propeller control – full forward to INCREASE.
- Throttle – open 1 inch.

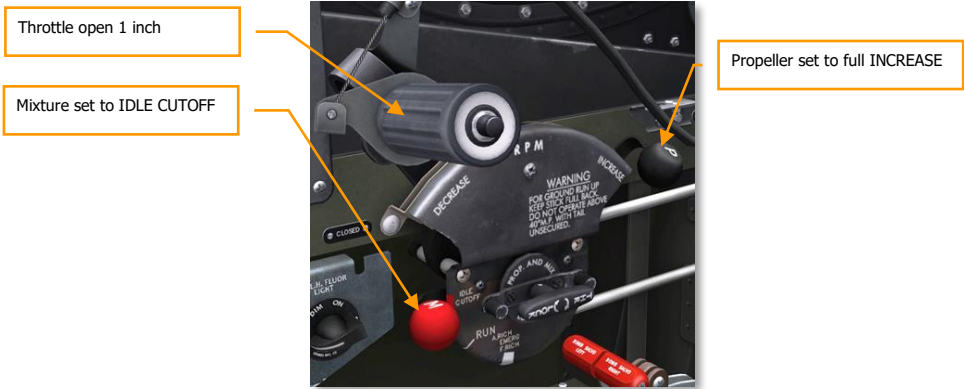

- Gunsight gyro selector switch – FIXED.
- Gunsight gyro motor switch – ON.

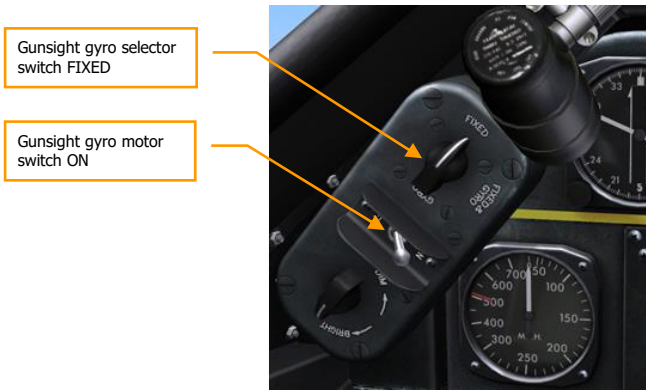

- Armament switches
  - Rockets switch SAFE.
  - Bombs switches OFF.
  - Gun safety switch OFF.



- Altimeter – zero or set at airfield elevation, as required.

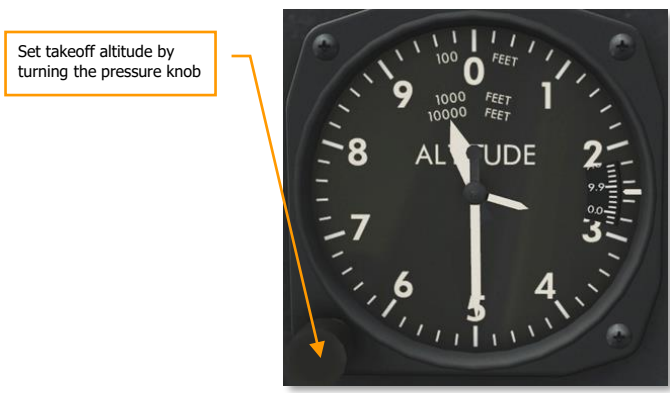

- Gyro instruments – uncage directional gyro (uncaged by default) and flight indicator.
- Controls – Check the stick and rudder controls to ensure they operate without binding. Watch the control surfaces for correct response.
- Parking brakes – set. Don't try to hold the aircraft with foot brakes.



- Supercharger – AUTO (set by default).
- Fuel shut-off valve – ON.

- Fuel selector valve – set to left wing tank.

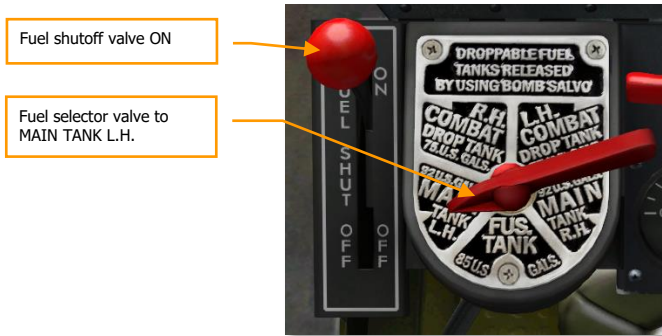

- Right fuel gauge – check gauge, located on floor at your right.



- Fuel booster – ON.



- Battery and generator switches – ON.

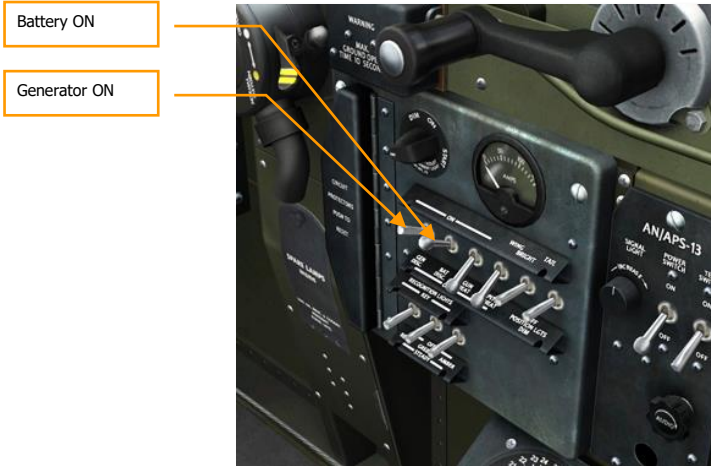

- Coolant and oil radiator flap control switches – operate manually from CLOSE to OPEN and check by listening to determine whether the doors are operating. Maintain both flap doors fully OPEN while running the engine on the ground (flap doors will be set to AUTOMATIC for takeoff).

**For all ground operations, the oil and radiator flap doors should be fully open to prevent overheating.**

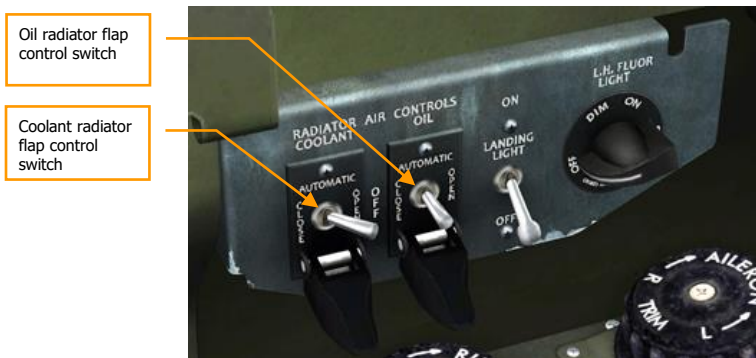

- Prime and start – having completed this left to right check, you're now ready to start the engine in accordance with the procedure provided below. Prior to doing so, the following items need to be checked, depending on the mission:

- Before any flight, check the landing gear warning lights by pushing on the lamp housings.
- If you expect to use oxygen, check the gauge for a pressure of 400 PSI.
- If night flying is anticipated, check all essential lights – instrument fluorescent lights, cockpit swivel lights, position and recognition lights, and landing lights.

## Start-Up

After completing the Pre-start check, proceed with engine start-up as follows:

- Prime the engine three to four seconds if it is cold, one if warm.
- Raise the starter switch cover and hold the switch up in the START position to operate the starter and begin turning the engine ([Home] key).



- After six propeller blades have passed the canopy, set the Ignition switch to BOTH while continuing to operate the starter.



- As the engine starts, move the mixture control to RUN and release the starter switch. If the engine fails to take hold after several revolutions, give it one second's more prime.

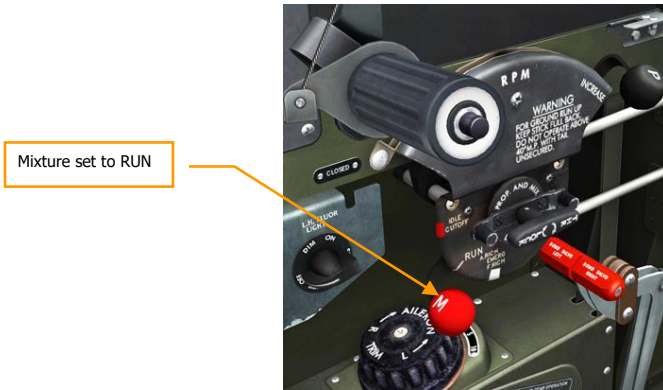

Mixture set to RUN

**If the engine cuts out after starting, return the mixture control immediately to IDLE CUT-OFF.**

- Check that oil pressure reaches at least 50 PSI within 30 seconds. If it doesn't, stop the engine.
- Idle at about 1200-1300 RPM until the oil temperature reaches 40°C and the oil pressure is steady.
- Check the suction gauge to show between 3.75 to 4.25" of vacuum pressure.
- Check all of the engine instruments. Make sure they don't exceed or fall below their limits.
- After the engine is warmed up, idle at 1000 RPM or slightly less. This keeps the engine clean but not too hot.



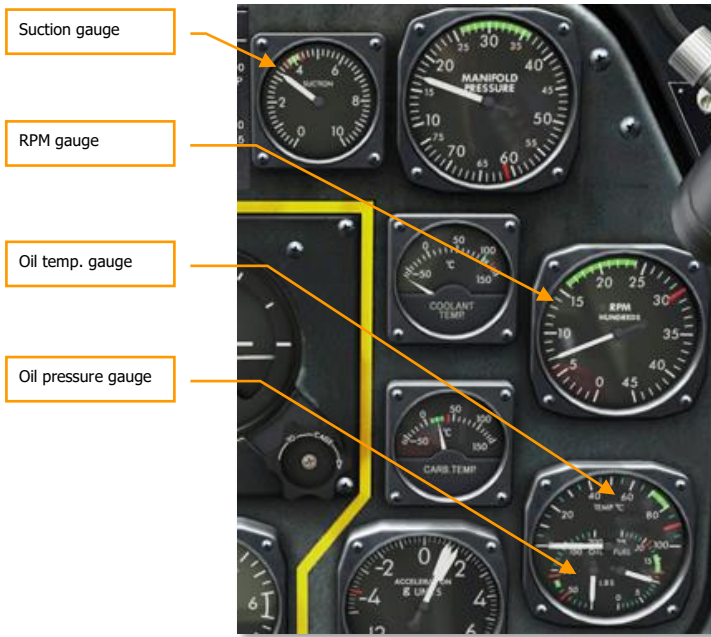

If for any reason you anticipate pulling more than 40" of manifold during the engine ground run, be sure that the airplane is anchored.

## Stopping the Engine

To stop the engine, follow the procedure below:

- Set the propeller control full forward. This makes the engine easier to start next time.
- Idle at 1500 RPM.
- Fuel booster – OFF.
- Move the mixture control to IDLE CUT-OFF, opening the throttle as the RPM drops below 700 RPM. Do not open the throttle above 700 RPM as any sudden opening of the throttle at this point discharges fuel into the carburetor and causes after-firing – the engine sputters and attempts to fire again.
- Ignition switch – OFF.
- Turn off all electrical switches. Don't forget the battery switch.
- Lock the controls, and move the carburetor air lever to UNRAMMED FILTERED AIR.

- If the parking brakes are to be used, give them plenty of time to cool or they may freeze in place. Avoid using the parking brakes unless dictated by conditions or tying the aircraft down overnight.

Consult the table below for a chart of manifold pressure and engine RPM limits for flight, as well as engine instrument limits.

**Table of Manifold Pressure and RPM Limits for Flight**

	Maximum Cruise	Maximum Continuous	Takeoff Maximum	Military Power	War Emergency
Manifold Pressure [in.]	42	46	61	61	67
RPM	2400	2700	3000	3000	3000

**Table of Engine Instrument Limits**

	Coolant Temperature	Oil Temperature	Oil Pressure	Fuel Pressure
Minimum	-	-	50 PSI	14 PSI
Desired	100°-110°C	70°-80°C	70-80 PSI	16-18 PSI
Maximum	121°C	105°C	-	19 PSI

## Taxiing

When the aircraft is in a 3-point attitude, the nose restricts forward visibility. This means that in taxiing, you must zig-zag (or "S-turn") continually.

Taxi with the canopy open. This not only aids visibility, but keeps the cockpit cooler on the ground. In ordinary taxiing, keep the stick aft of neutral. This locks the tail wheel and makes it steerable through 6° right or left with the rudder pedals. To make sharp turns or to go around corners, unlock the tail wheel by pushing the stick full forward. In this position the tail wheel is full swiveling. Be careful not to start a sharp turn before unlocking the tail wheel – it tends to bind.

Throttle back when taxiing and use the brakes as little as possible. There is no point in wasting a lot of gasoline and burning up your brakes on the taxi strip.

## Preflight Check

Prior to takeoff, perform the following preflight check:

- Primary controls:
  - Check surface controls for free movement.
- Instruments and switches:
  - Altimeter set.
  - Directional gyro set.
  - Flight indicator set.
  - All instrument readings in desired ranges.
  - All switches and controls at desired positions.
- Fuel system:
  - Check fuel tank selector handle on MAIN TANK L.H. Ensure selector is in detent.
  - Fuel booster pump switch set to ON.
  - Primer switch set to OFF.
- Flaps:
  - Flaps set for takeoff (UP for normal takeoff, 15 - 20° down for minimum run takeoff).
- Trim:
  - Rudder trim: 6° right.
  - Aileron trim: 0°.
  - Elevator trim: 0° if fuselage tank is filled with less than 25 gallons of fuel; 2 - 4° nose heavy if the fuselage tank is filled with more than 25 gallons of fuel.
- Pre-flight engine check:
  - Check propeller at full INCREASE.
  - Power check – advance throttle to obtain 2300 RPM. At this RPM, the manifold pressure should read ½ in.Hg less than field barometric pressure within +/- ½ in.Hg.

**Manifold pressure in excess of field barometric pressure indicates the engine is not producing maximum power and should be checked.**

- Ignition system check
  - At 2300 RPM, with the propeller in full INCREASE, move ignition switch from BOTH to L, back to BOTH, then to R, and back to BOTH. Allow engine speed to stabilize at

BOTH between checks. A maximum drop of 100 RPM is allowable for the right magneto and 130 RPM drop for the left magneto. If RPM drop is more than allowable, spark plugs will have to be deledaded.

- Idle speed check – idle engine at 650 to 700 RPM with throttle against idle stop.
- Acceleration and deceleration check - with mixture set to RUN, advance throttle from idle to 2300 RPM. Engine should accelerate and decelerate smoothly with no tendency to backfire.
- Carburetor ram-air control lever set to RAM AIR (UNRAMMED FILTERED AIR or HOT AIR only if required).
- Mixture control set to RUN.
- Supercharger control switch set to AUTO.
- Oil and coolant radiator air control switches set to AUTOMATIC.

**Do not exceed 40 in.Hg during ground run-up without having the tail tied down, because of the possibility of the aircraft nosing over.**

## Takeoff

### Normal Takeoff

Follow the below procedure to perform a normal takeoff:

- Be sure takeoff area is clear and check final approach for inbound aircraft.
- Release brakes and line up for takeoff.
- Advance throttle smoothly and steadily to Takeoff Power (61 in.Hg MP at 3000 RPM).
- Do not attempt to lift the tail too soon as this increases directional instability. Pushing the stick forward unlocks the tail wheel, thereby making steering difficult. The best takeoff procedure is to hold the tail down until sufficient speed for rudder control is attained and then to allow the tail to rise slowly. Some rudder input may be necessary to maintain heading as the tail is lifted and stabilized in a takeoff attitude.

It is recommended that 61 in.Hg and 3000 RPM be used for takeoffs and that this power setting is reached as quickly as possible after the takeoff run is started. However, advance the throttle smoothly and never jam it forward. Torque effects appearing from a sudden onset of power can lead to a loss of directional control of the aircraft.

When a formation takeoff is performed, a lower power setting of 55 in.Hg may be used to allow the wingmen room for increased power over the leader in order to maintain their position.

If rough engine occurs during the takeoff run, immediately throttle back 4 or 5 in.Hg manifold pressure to complete the takeoff if conditions permit. Throttling back tends to decrease the intensity of detonation or preignition and minimizes the chances of engine failure. If this condition occurs on takeoff, the spark plugs must be changed before the next flight.

**Avoid sudden bursts of power during takeoff! Make it smooth and steady.**

## Minimum-Run Takeoff

To accomplish a minimum-run takeoff, lower flaps to 15 - 20°. Keep the aircraft in a three-point attitude and allow it to fly itself off the ground in this position. As soon as airborne, allow airspeed to build up and climb out when speed exceeds 100 mph. Retract landing gear when airspeed reaches a safe value. Raise flaps above 200 feet altitude.

## Crosswind Takeoff

The following procedure is recommended for a crosswind takeoff:

- Advance throttle to Takeoff Power (61 in.Hg at 3000 RPM).
- Hold the tail down until sufficient speed is attained to ensure positive rudder control. Speed should be slightly greater than for normal takeoff.
- Apply sufficient aileron control to keep wings level or even to effect a slightly wing-low attitude into the wind.
- Keep the aircraft firmly on the runway until speed is sufficient to make a smooth, clean break.
- After becoming airborne, crab into the wind enough to counteract drift.

## After Takeoff

Perform the following steps once a safe takeoff is accomplished:

- Raise the landing gear by pulling the landing gear lever inward and up. Be sure the lever catches in the up position. In a minimum-run takeoff, raise the flaps when altitude is at least 200 feet, a sufficient airspeed has been attained and all obstacles have been cleared.
- Check coolant and oil temperatures, and oil pressure.

**Do not apply brakes after takeoff to stop rotation of the wheels to prevent the brake disks from seizing.**

- After reaching an altitude of 500 feet, throttle back to 46" of manifold at 2700 RPM.
- Re-trim the aircraft for climbing attitude as necessary.
- Check all of your instruments for proper function within normal parameters. In doing so, be sure to check the ammeter indicator showing proper charging from the generator. Immediately after takeoff, the rate of charge should not exceed 100 amps, dropping back to the normal 50 amps or less after 5 minutes of operation. If the charge does not reduce, turn the generator disconnect switch to OFF and return to the airfield. Also check the hydraulic pressure to read approximately 1000 PSI after the landing gear has been retracted.

Optimum climb to altitude speed is approximately 170 mph.

# Landing

## Descent

Before descent, turn the windshield defroster control knob ON. Descent may be carried out at any safe speed down to the recommended margin of about 25 percent above stalling speed. With the landing gear and flaps up, the glide is fairly flat with the nose high. Forward visibility is poor in this condition, and in traffic areas, a series of "S-turns" should be employed to prevent a possible collision. Lowering either the flaps or landing gear, or both, greatly increases the gliding angle and the rate of descent.

## Approach Check

When approaching the field for a landing, perform an approach check, which includes the following steps:

- Fuel – select fullest internal tank for landing.
- Fuel booster pump – set to ON.
- Mixture control – set to RUN (AUTO RICH on earlier aircraft).
- Carburetor ram- and hot-air control levers – as required.
- Oil and coolant radiator air control switches – set to AUTOMATIC.
- Clean out the engine at 3000 RPM and 61 in.Hg for 1 minute.
- Prop control – forward to 2700 RPM.
- Landing gear – move lever to DOWN. Check indicator to see that the gear is down and locked. Note, the gear should be lowered at 170 mph or less.
- Flaps – full down. Note, flaps are usually lowered for the turn to final approach.
- Shoulder harness – lock harness and check by leaning forward against it.

The traffic pattern used may vary depending on the airfield and local conditions. Regardless of the traffic pattern used, keep the pattern in close enough to the field and at sufficient altitude so as to bring the aircraft in safely even with the power off if necessary.

In preparing to peel off, control your airspeed. The greater the speed, the longer it takes to slow down. Peel off should be performed at speeds no greater than 200-225 mph.

## Landing Procedure

Perform the following steps when preparing to land:

- Slow down to 170 mph before lowering the landing gear.

- When lowering the landing gear, make sure the control handle is DOWN and locked. Check the landing gear indicator lights. Be sure the hydraulic pressure returns to approximately 1000 PSI. Be prepared for the aircraft to feel nose-heavy when the gear is down. Adjust elevator trim to compensate.
- Maintain approximately 150 mph IAS in the traffic pattern.
- Lower the flaps when turning on final approach and the airspeed is below 165 mph IAS.
- Once lined up on final and with the flaps lowered, maintain approximately 115-120 mph IAS.
- When sure of a correct landing approach, close the throttle.
- Just before getting to the runway, break the glide with a controlled flare and approach so as to land within the first third of the runway in a 3-point attitude.
- Hold the aircraft in the 3-point attitude just above the runway until flying speed is lost and the plane sets down at approximately 90 mph.

The tail wheel is locked when the stick is neutral or aft, so steering is limited after touchdown. Keep the stick held back until enough speed is lost and you are ready to turn off the runway and taxi.

Never attempt to push the stick forward and unlock the tail wheel in a turn when taxiing. Release the tail wheel before starting the turn.

The illustration below demonstrates the landing procedure:

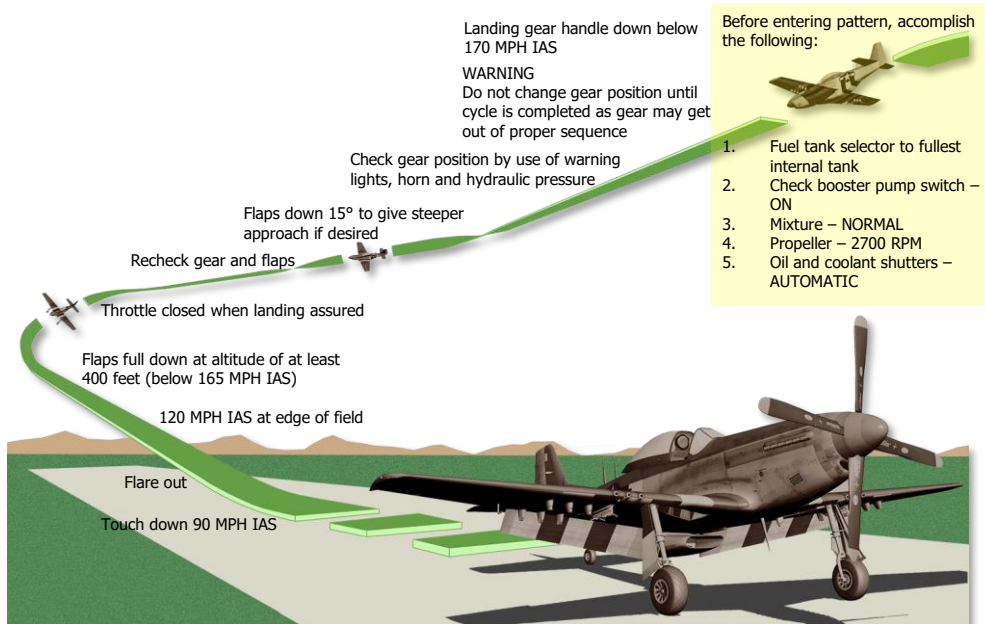

**Figure 92: Approach and landing procedure**

## After Landing

After landing, clear the runway as soon as possible and perform the following steps:

- Set throttle at 1000 RPM.
- Open canopy.
- Set oil coolant and radiator air control switches to OPEN. Release switches to OFF when flaps are fully open.
- Raise wing flaps completely.
- Set trim tabs to neutral.
- Set propeller control to full INCREASE.
- Set fuel booster pump to OFF.



## Special Landing Conditions

### Crosswind Landings

The recommended procedure for crosswind landing is as follows:

- Maintain airspeeds slightly higher than for a normal approach.
- Drop the wing into the wind slightly to counteract the drift, and keep the plane straight with the runway.
- Just before touching down, level the wings.
- Be sure to keep the stick back after touch down so that the tail wheel will remain locked.
- Make a wheel landing if the crosswind is excessive, gusty, strong, or otherwise doubtful. Use approximately half flaps for any appreciable crosswind.

If crabbing is required during the approach, be sure to straighten out before landing. Never land in a crab as it is very stressful on the landing gear.

### Gusty Landings

In a gusty wind condition, maintain speeds slightly faster than normal to minimize the likelihood of a sudden loss of lift between wind gusts. Watch for the effect of gust on the aircraft. The gust tends to have a ballooning effect. Then, when the gust quits, the aircraft may drop as lift is reduced, resulting in an impact with the ground.

Use about half flaps when performing a landing in gusty conditions.

### Wet Landings

Wet landings require special attention in using the brakes. Avoid jamming the brakes, which could result in skidding out of control. If visibility out of the front windshield is poor, use the front panels on each side of the windshield.

## Landing Go-Around

Don't hesitate to go around if there is any possibility of a problem occurring while landing. The recommended go-around procedure is as follows:

- Advance the throttle quickly but smoothly to a manifold pressure of 46" at 2700 RPM. Avoid a sudden rush of power to prevent a possible loss of control due to increasing torque effects.
- As power is increased, counteract left torque by using right rudder and right trim tab.
- Raise the landing gear.
- Trim the aircraft to relieve the elevator pressure.

- After your IAS reaches 120 mph and altitude reaches 500 feet, raise the flaps. Bring them up gradually, about 10° at a time. Monitor the change in attitude as the flaps are raised.
- Set oil and coolant radiator flaps as necessary for continued flight.

**Do not make sudden and large throttle movements. Use all of the controls smoothly to avoid a loss of control.**

If the aircraft has been trimmed for landing, it may take considerable stick-forward pressure to maintain the nose down until the elevator is re-trimmed.

It's critical to maintain a straight course until enough airspeed is gained to raise the flaps and begin maneuvering.

## Cold Weather Operation

### Starting the Engine

More than normal priming is required at low temperatures during the starting procedure and immediately after combustion until smooth engine operation is obtained. It is not considered harmful to prime continuously when necessary during the entire cranking period, but prime only when the engine is turning over.

**Do not open the mixture control until the engine is firing to prevent excess fuel in the induction system. If the engine has not started after 2 minutes of cranking, disengage the starter and allow it to cool for one minute before making another attempt.**

**If there is no oil pressure after 30 seconds running or if the pressure drops to 0 after a few minutes of ground operation, stop the engine immediately and investigate to prevent excess wear and damage.**

### Before Takeoff

- Hold down the brakes and run up the engine until spark plugs burn clean and the engine is operating smoothly before performing the ignition system check.
- Check flight controls for freedom of movement.
- Use carburetor heat as required to keep the carburetor air temperature within limits to improve engine operation during takeoff.
- Turn the pitot heat switch to ON just before takeoff.

## Takeoff

At the start of the takeoff run, advance the throttle to Takeoff Power as rapidly as possible to ensure that the rated takeoff power is obtainable. Abort the takeoff if required power is not available, because engine failure may occur.

## After Takeoff

Turn on the gun heaters.

## Engine Operation in Flight

Use carburetor heat as required to improve fuel vaporization and combat carburetor icing, but do not use carburetor heat above 12,000 feet as resultant excessively lean mixtures will cause engine roughness due to the effect of heat on the altitude compensator of the carburetor.

**Because of the constant-speed propeller and the automatic manifold pressure regulator, it is difficult to detect carburetor ice formation except by irregular engine operation.**

## Systems Operation in Flight

Increase propeller speed momentarily by approximately 200 RPM every half hour to ensure continued governing at extremely low temperatures. Return to desired cruising RPM as soon as the tachometer indicates proper governing.

## Approach

- Since temperature inversions occur frequently in cold environments, avoid engine overcooling during descents.
- Use carburetor heat when outside air temperatures are below  $-12^{\circ}\text{C}$  ( $10^{\circ}\text{F}$ ).
- Turn off all nonessential electrical equipment at least one minute before final approach to reduce battery load when the generator cuts out.
- Pump the brakes to chip away any accumulated ice.

# EMERGENCY PROCEDURES



# EMERGENCY PROCEDURES

## Engine Emergencies

### Engine Overheating

Engine overheating can be recognized by one or more of the following effects: coolant relief valve pop-off, maximum coolant temperature being exceeded, or white smoke coming from the exhaust stacks. An engine overheating in flight is likely caused by one of the following:

- You have been climbing at high power and below recommended airspeed. In other words, the air blast in the air scoop is insufficient. To remedy this problem, level out, reduce power and increase airspeed.
- The automatic shutter controls are not functioning properly. In this case, operate the shutters manually by means of the toggle switch control, and watch the instruments to see if the condition has been remedied.
- The oil supply is depleted. This situation may be discovered by reading the oil pressure gauge. The engine will continue to overheat even after the shutters are opened all the way. There is no fix for this problem, so maintain the RPM and power as low as possible and land as soon as possible.
- The coolant supply is depleted. The engine will continue to overheat even after the shutters are opened all the way. There is no fix for this problem, so maintain the RPM and power as low as possible and land as soon as possible. You may only have about 10 minutes before the engine fails.
- The engine's operating limits have been exceeded. Make sure the carburetor air control is set to RAM AIR, depending on the type of equipment. Check the mixture control to see that it is set to RUN or AUTO RICH.

If conditions are favorable for a dead-stick landing and overheating persists, consider the possibility of shutting down the engine prior to landing.

### Engine Failure

Engine failures fall into two main categories: those occurring instantly and those giving ample warning. The instant failure is rare and usually occurs only if ignition or fuel flow completely fails. Most engine failures are gradual and afford the alert pilot ample indication that a failure may be approaching. An extremely rough-running engine, loss of oil pressure, excessive coolant temperature under normal flight conditions, loss of manifold pressure, and fluctuating RPM are indications that a failure may occur. When indications point to an engine failure, the pilot should land immediately.

## Engine Air Restart

If the engine fails in flight and you have sufficient altitude, you may attempt a restart, provided the engine did not fail for obvious mechanical reasons. Unless the engine seizes or internal structural failure occurs, the propeller will windmill even at minimum glide speed. Should airspeed inadvertently drop to a value where the propeller ceases to rotate, the aircraft should be nosed down to regain additional speed. In nearly all cases, the propeller will start to rotate again. If necessary, the starter may be used to turn the engine over. All unnecessary electrical equipment should be turned off before the starter is used. Use starting procedure after checking fuel tank selector handle on fullest tank.

## Engine Failure in the Takeoff Run

The chances of engine failure during takeoff can be greatly reduced if the engine is run up carefully and checked thoroughly beforehand. If engine failure occurs during the takeoff run before the aircraft leaves the ground, proceed as follows:

- Close throttle completely.
- Apply brakes as necessary to effect a quick stop.
- If doubt exists as to whether the aircraft can be brought to a safe stop on runway, ignition switch should be set to OFF and fuel shutoff valve lever to OFF.
- If insufficient runway remains for a safe stop or obstacles cannot be avoided, jettison external load and move landing gear handle UP.
- Roll canopy back or pull canopy emergency release handle.
- After stopping, get out of the aircraft as soon as possible, and remain outside.

## Engine Failure after Takeoff

If an engine failure occurs soon after takeoff, the pilot has to think fast and take the correct course of action before too much speed is lost and not enough safe ground is available for a landing. Perform the following steps:

- Move Mixture control to FULL RICH (or EMERGENCY RICH) if the engine begins to fail.
- If failure persists, immediately lower the nose to maintain airspeed.
- Pull the Bomb Salvo handles to release external bombs or tanks, if loaded.
- Release the canopy by pulling the Canopy Emergency Release handle.
- If a safe landing is in doubt, move the landing gear handle to UP.
- If time permits, lower the flaps.
- Move mixture control to IDLE CUTOFF.
- Turn ignition switch OFF.
- Move fuel shutoff lever to OFF.
- Turn the battery disconnect switch to OFF.

- Secure the shoulder harness.
- Land straight ahead.
- After landing, get out and stay out.

## Engine Failure in Flight

If the engine begins to fail during flight, immediately move the mixture control to FULL RICH (or EMERGENCY RICH). If the engine fails during flight, the aircraft may be abandoned, ditched, or brought in for a dead-stick landing. To land with the engine dead, follow these steps:

- Lower the nose immediately so that airspeed does not drop below stall speed. Keep IAS well above stall speed.
- If external tanks or bombs are installed, release them over an uncongested area by pulling the Bomb Salvo release handles.
- Set the fuel shutoff lever to OFF.
- Set the battery disconnect switch to OFF, unless electrical power is desired for operating the lights or radio.
- Choose an area for landing. If near a landing field, notify the tower. Judge turns carefully and plan to land into the wind.
- Duck your head, lower the seat, and release the sliding canopy by pulling the Canopy Emergency Release Handle.
- If a long runway is available and time and altitude are sufficient to properly plan an approach, set the landing gear handle to DN. If landing under any other condition, keep the gear up.
- Set wing flaps to 30°, leaving another 20° for compensation of possible mistakes in the final approach. Lower the flaps fully when a safe landing is not in doubt.
- Land into the wind.
- After landing, get out and stay out.

## Runaway Propellers

Failure of the propeller governor is quite rare, and the chances are that you will never encounter it. When it does happen, the prop runs away, that is, the blades go to full low pitch, resulting in engine speeds as high as 3600 RPM or more. Obviously, this speed must be reduced immediately or the engine will be completely ruined, necessitating a forced landing or a bailout.

If a runaway propeller situation is encountered, perform the following procedure:

- Pull the throttle back to obtain 3240 RPM, the maximum allowed diving overspeed of the engine.
- Raise the nose of the aircraft to lose speed, and when you're flying high, return gradually to a moderate altitude. Keep the speed at approximately 140 mph IAS.
- When you reach a landing field, lower the gear and make a normal landing.

## Fire

In the event of a fire, keep the canopy entirely closed. Opening the canopy will result in it quickly filling with smoke. Similarly, do not lower the landing gear as this may also blast the fire into the cockpit.

If an engine fire develops, attempt to control the fire by performing the following steps:

- Mixture control to IDLE CUTOFF.
- Fuel shutoff lever to OFF.
- Throttle CLOSED.
- Ignition switch to OFF.
- Battery disconnect switch to OFF, unless power is desired to operate the radio or lights.

While remaining in the cockpit during a fire, cover all the exposed parts of your body, including your eyes. If the fire situation requires bailing out, only open the canopy when you are ready to leave the aircraft. Don't release the canopy until after you have unlocked the safety harness, trimmed the aircraft, and are crouched with your feet in the seat ready to spring out. Then pull the canopy emergency release handle and lunge upward to the right, pushing the canopy off with the head.

## Landing Emergencies

### Forced Landing Over Doubtful Terrain

If a forced landing over doubtful terrain is unavoidable, don't hesitate to attempt a belly landing. Forced landing with wheels down should be made only when absolutely certain that such a procedure is safe.

### Belly Landing

When a belly landing is unavoidable, it's best to perform the landing on a hard surface. On soft or loose ground, the air scoop tends to dig in, not only stopping the aircraft suddenly, but also causing more damage to the airframe than a hard-surface belly landing.

#### Belly Landing Procedure

- Keep the wheels up.
- Jettison any tanks and bombs.
- Lower the seat, duck your head, and jettison the canopy.
- Make sure your shoulder harness and safety belt are locked.



- Use about 30° of flaps until just before landing. Lower the flaps fully once sure of the landing area.
- Maintain a speed of about 120-130 mph until contact is achieved.
- Approach in a 3-point attitude to slow the aircraft.
- Cut the switches just before impact.
- As soon as the aircraft stops, get out and move to a safe distance as quickly as possible.
- Unless assistance is available nearby, stay close to the aircraft to assist a searching party in locating your position. Consider using oil or gasoline to start a signal fire if conditions allow.

## Forced Landing at Night

If a forced landing is necessary at night, it is recommended to bail out unless visibility conditions are exceptionally good. Don't attempt a night-time forced landing – even a belly landing – unless there is radio contact with a ground controller, you are in direct vicinity of a known airfield, and are sure the aircraft is in a sufficient condition for a safe landing.

## Brake Failure

Remember that the brake system is not operated by the hydraulic system of the aircraft and that each brake is operated by its own individual pressure cylinder, which is activated by using the brake pedals. It is extremely unlikely, therefore, that both brakes will fail at the same time. When one brake fails, it is almost always possible to use the other in stopping the aircraft.

If one brake goes out while taxiing, use the other (good) brake and also the lockable tail wheel. Immediately chop the throttle and cut the switch. If you're going too fast to stop the aircraft in this matter, lock the good brake, and groundloop until the aircraft stops.

If a brake goes out while checking the magnetos, immediately cut the throttle back and hold the plane in a groundloop with the good brake.

If, when coming in for a landing, you know that your brakes are inoperative – or even if you suspect such a condition – approach the field and land as slow as safety permits. Use full flaps and use your best technique in making a 3-point landing. Stop the engine completely by cutting the mixture control as soon as your plane is on the ground. The dead prop creates additional braking action to help make your landing as short as possible.

If the brakes are locked, never attempt a wheel-type (tail high) landing. If you do, you will either hit the prop or nose over altogether.

## Hydraulic System Failure

If the hydraulic system fails, remember that you can lower the landing gear by pulling the emergency knob. The procedure is as follows:

- Put the landing gear control handle in the DOWN position. This releases the mechanical locks which hold the gear in place.
- Pull the red emergency knob. This releases the hydraulic pressure in the lines and allows the gear to drop of its own weight.

It's possible that the gear may not fall with sufficient force to lock itself in place. To avoid this problem, rock the aircraft side to side **while continuing to pull the red emergency handle** until the gear catches in the locked position.

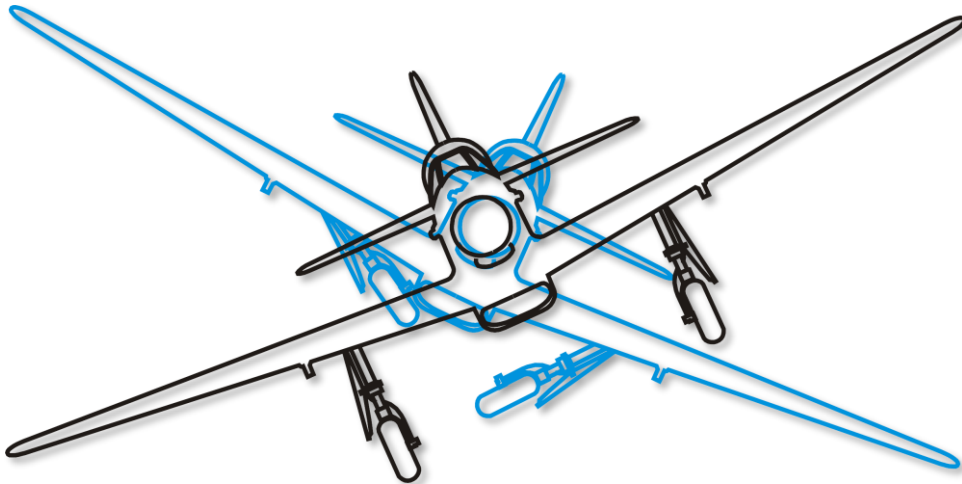

**Figure 93: Rock It To Lock It**

The tail wheel usually locks without any difficulty. If it doesn't, speed up the aircraft to force the partially extended wheel into position by means of greater air pressure on it. Alternatively, perform a dive followed by a pull up with enough acceleration to force down the tail wheel.

## Electrical System Failure

The aircraft's electrical system circuits are protected by circuit breakers on the right hand panel. These switches are controlled by a single bump plate hinged across them, making it possible to reset all of the buttons at one time, and doing away with the necessity of hunting for the right switch.

If a circuit is overloaded, it will pop slightly out of the panel. To reset, wait a few seconds for the switch to cool, and then give the bump plate a firm push. If the switch pops out again immediately, allow a bit more cooling time and try again. Should repeated efforts fail to restore the switch, there's nothing more that can be done to fix it. The circuit is probably shorted and cannot be repaired in flight.

If the ammeter shows that something has gone wrong with the electrical system and the battery is overcharging, cut the generator disconnect switch by setting it to OFF. Be careful not to overcharge the battery.

Whenever the generators are shut off, the radio must be used sparingly as it quickly drains the battery.

If the ammeter shows that the battery is undercharging, check the generator disconnect switch to make sure that it hasn't been turned OFF accidentally. If the generator switch is still set to ON and the battery is not charging properly, use your radio only when necessary. Make the best use of whatever battery power remains.

Remember, if the electrical system fails completely, the ignition system continues to operate on the magnetos. However, the oil and coolant scoops will be inoperative, since they are controlled electrically.

## Tire Failure

If a tire is low or blown out during a landing approach, perform a 3-point landing. Don't use the brakes until necessary, then use the opposite brake, but only slightly, and enough opposite rudder to keep the aircraft straight.

Land on the left side of the runway if the right tire is flat and on the right side if the left tire is flat.

If a tire is completely lost, do not attempt to land on a rim. Perform a belly landing.

## Ditching

Never attempt to ditch a P-51 except as a last resort. Fighter aircraft are not designed to float on water, and the P-51 has an even greater tendency to dive because of the air scoop position under the fuselage. It will go down in 1 ½ to 2 seconds.

It is possible to ditch the P-51 successfully and it has been done on several occasions. However, it is a hazardous situation. If a problem arises over water and if reaching land is impossible, bailing out is preferred to ditching. In most situations, it should be possible to pull up to at least 500 feet to make a safe jump. In such a case, perform as steep of a climb as possible to exit the aircraft at the highest possible altitude. When bailing out, it is recommended to use the right side of the aircraft due to the slipstream helping to clear the tail section safely.

## Radio Procedure

Refer to the section below on bailing over water for the correct radio procedure prior to ditching the aircraft. Accomplish as much of the procedure as circumstances permit. Chances of a successful rescue depend heavily on whether an Air/Sea Rescue Unit can get an accurate fix on the location of the incident.

## Approach and Touchdown

Make an approximation of wind velocity based on the appearance of the water. If the wind is judged to be less than 35 mph, touch down parallel with the lines of wave crests and troughs. Ditch into the wind only if its velocity is over 35 mph, or if the sea is flat.

Keep the wheels up, and use flaps in proportion to available power in order to obtain minimum forward speed with minimum rate of descent. Approach in a 3-point attitude, and observe the following procedure:

- Lower the seat, duck your head, and jettison the canopy.
- Jettison tanks or bombs, if equipped.
- Unfasten the parachute harness.
- Make sure that your shoulder harness and safety belt are locked and tight.
- Maintain an airspeed of 120 mph.
- Cut the switches just before impact.
- Touch down in normal landing attitude.
- Deceleration following impact will be very violent. Once the aircraft stops, you will not have more than 2 seconds to exit the cockpit, so be prepared to quickly perform the following steps:
- Release the safety belt.
- Jump out and pull the life raft loose from the parachute.
- Inflate the "Mae West" life vest immediately after discarding the parachute harness.
- Inflate the life raft and get inside.
- Always keep the life vest on, even in shallow water. Also, attempt to salvage the parachute, if possible, as it may be a useful resource.

## Bailing Out

There are several methods of bailing out of the P-51D, when the aircraft is under control. However, the following bailout procedure is recommended, because it remains essentially the same whether the aircraft is under control, on fire, or in a spin.

- Slow the aircraft to the lowest speed that is reasonably safe – usually about 150 mph. The lower the speed during a bailout, the less risky it is. Avoid slowing down to a stall, particularly if there is no power.
- Lower the seat, duck your head, and jettison the canopy.
- Disconnect the headset and oxygen hose, and release the safety belt and shoulder harness.
- Pull yourself up onto the seat so that you are in a crouching position with your feet on the seat.

- Dive with head down toward the trailing edge of the right wing, unless a fire or some other condition makes it advisable to go out the left side.

## Bailout at High Altitude

If a problem occurs at high altitude, attempt to reduce altitude before bailing out. If reducing altitude is not possible, open the emergency knob on the oxygen regulator and fill your lungs with oxygen by taking several full breaths. Hold your breath as long as possible during free fall to reduce problems associated with cold rarified air at high altitudes. Also, when bailing out at high altitude, it is recommended to extend the free fall until lower altitudes are reached, as opening the chute at higher altitudes induces greater G loads on the body.

## Bailout in a Spin

When bailing out during a spin, it is recommended to jump on the side inside the spin, as opposed to the outside. This helps avoid hitting the airframe during the jump.

## Bailout over Water

When bailing out over water, it's critical to follow a definite radio procedure in order to maximize the chances of a quick rescue. If possible, gain altitude in order to increase the range of the VHF radio and help Air/Sea Rescue unit attain a fix of your location. General steps for a radio procedure are as follows:

- Notify wingmen of your status.
- If equipped with an IFF set, turn the emergency switch to ON.
- Transmit "Mayday" three times, followed by the call sign of your aircraft three times.
- Your first transmission will be on the assigned air-ground frequency. If communication cannot be established on this frequency, use any other available frequency to establish contact with a ground station.
- If time permits, provide the following information:
  - Estimated position and time.
  - Course and speed.
  - Altitude.
  - Intent as to bail out or ditch.
- Just before bailing out, break the safety wire on the VHF control switch and throw the switch to T/R.
- In case the situation normalizes and bailing out is no longer necessary, be sure to cancel the distress call on the same frequency.

# COMBAT EMPLOYMENT



## COMBAT EMPLOYMENT

In this section, we will overview weapon employment procedures for the P-51D.

### Guns

#### Aiming with the K-14 Gunsight

The K-14 gunsight contains two aiming sights: the compensating (gyro) sight and the fixed sight. In the fixed sight, a crosshair represents the aiming pipper. The two sights can be used simultaneously or selectively. Using both sights simultaneously can provide a helpful indication of the amount of lead the gyro sight is generating from the boresight position. In this case, it's best to mask the fixed sight ring in order to declutter the aiming line of sight.

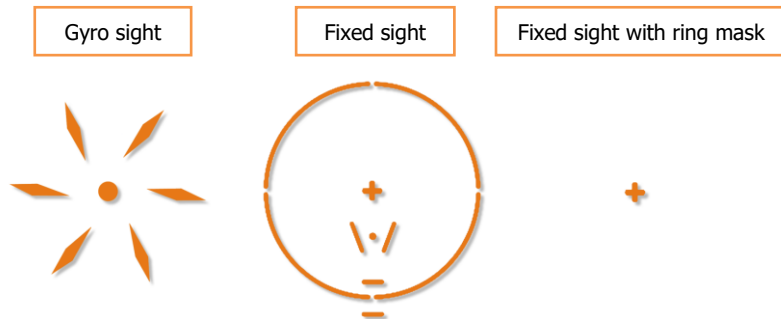

**Figure 94: K-14 Sight Reticles**

The fixed sights consist of the crosshairs and a 70-mil ring (when unmasked). The gyro sight consists of a dot surrounded by six diamonds. Using the gyro sight, aiming is accomplished by maneuvering the aircraft to position the dot directly over the target and keeping the enemy aircraft surrounded by the six diamonds until the kill is made.

The front of the sight panel includes a span scale, calibrated from 30 to 120 feet. The scale is set to match the expected enemy aircraft wingspan prior to the start of an engagement.

The Throttle Control handle incorporates a twist grip. The grip is attached to the sight by cable and pulleys, ending with a range pulley containing a dial calibrated from 600 to 2400 feet.

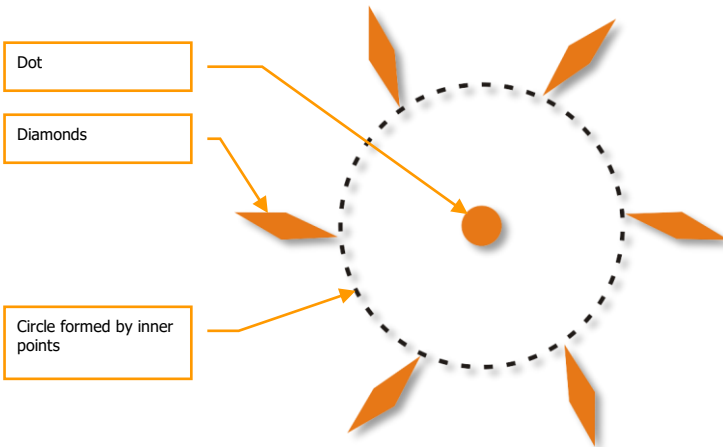

**Figure 95: Throttle Control Handle with Twist Grip**

When the twist grip is positioned to full counter-clockwise, the indicator points to 2400 feet on the dial. As the grip is turned, the range dial indicator moves to show the set target range.

As the aircraft is maneuvered to place and keep the dot on the enemy, the twist grip is turned to continually adjust the size of the reticle of diamonds so that the target is surrounded by the inner points of the diamonds. The dot must be kept on target for a duration of one second before firing to give the sight time to calculate the correct lead angle.

An imaginary circle should be visualized to connect the inner points of the diamonds to create a continuous aiming reticle.



**Figure 96: Gyro Sight**

When preparing for an engagement, the twist grip should be set to the minimum range of 600 feet. The same should be done when switching from one target to another.

When beginning to aim at a target, the range should be maintained at the minimum setting until the dot is at or near the target. Then the twist grip is used to set the correct range by framing the target



inside the diamond circle. This procedure reduces over-ranging, prevents over-correction, and most quickly achieves a firing solution.

When the target aircraft is at right angles - a  $90^\circ$  deflection shot - the wings cannot be used to set the sight frame, even if the target is banking. On most aircraft, the distance from the cockpit to the extreme end of the tail is approximately half of the wingspan. Therefore, correct aim can be achieved by placing the dot on the cockpit with the imaginary circle touching the tail.

Note that the circle is on the extreme end of the tail; not just the assembly.

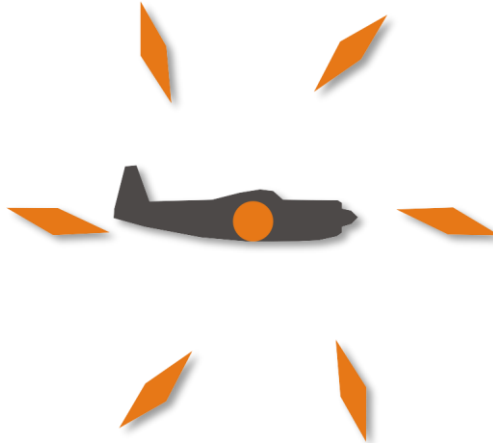

**Figure 97: Target  $90^\circ$**

If neither the wings nor the fuselage are at right angles, the frame must be made slightly larger than the aircraft to compensate for the viewing angle. If wings and fuselage are at  $45^\circ$ , an additional  $1/6$  of the diameter should be added, or  $1/3$  of the radius, on each side of the target, ranging on the tip of the wings and the tip of the tail. This is the maximum allowance. One-tenth of the diameter of the reticle serves for most purposes.



**Figure 98: Target's Wings and Fuselage are at 45°**

When the separation of the fixed cross and the dot shows that a long lead, around 85 to 100 mils, is being allowed, any small ranging error is magnified by distance and makes long range firing unprofitable. When only a short lead is indicated, small ranging errors are unimportant. Fire is effective at maximum range.

When closing in on a target at ranges of less than 600 feet, the diamonds can be ignored altogether. Effective fire can be made by simply keeping the dot on target.

Both the gyro and fixed sights are seen on a reflector plate. They are focused to infinity by means of collimator lenses. Parallax effects have been reduced to a minimum, which prevents a shifting of the target in relation to the reticle when moving the pilot's line of sight through the gunsight.

The illustration below demonstrates correct and incorrect aiming solutions for a number of likely engagement scenarios.

## Target Pattern. Right and Wrong

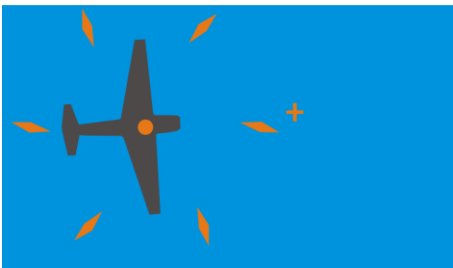

Correct – You have exact range now. Fire!



Incorrect – Dot is not on target.

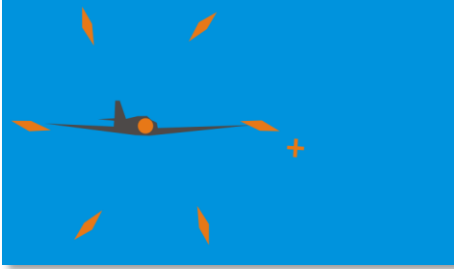

Correct – Circle of diamonds corresponds to target's wingspan.

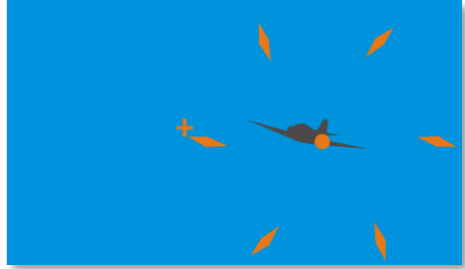

Incorrect – Circle of diamonds is too large, making range and lead angle wrong.



Correct – On broadside attacks the circle should be a trifle larger than length of fuselage, as wingspan is greater than length.

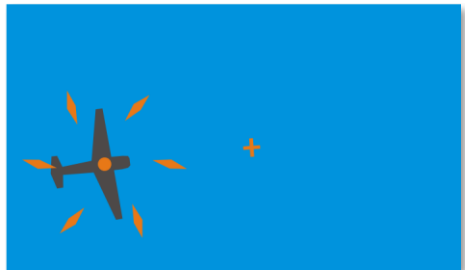

Incorrect – Imaginary circle formed by inner tips of diamonds should correspond to target's wingspan.

## Pre-flight Check of the K-14 Gunsight

Before takeoff, check the sight as follows:

- Gun Safety switch set to GUNS, CAMERA & SIGHT.
- Gyro Selector switch set to FIXED & GYRO. Both reticle images should appear on the reflector glass.
- Rotate sight dimmer rheostat to obtain desired brilliance.
- Pick a point on the horizon; make sure gyro reticle image dot is superimposed on fixed-reticle cross.
- Rotate throttle twist grip to check operation of gyro reticle image circle from minimum to maximum range.

## Firing Guns with the K-14 Gunsight

Normal flight operation of the sight is accomplished as follows:

- Gun Safety switch set to GUNS, CAMERA & SIGHT.
- Identify target; then set span adjustment lever to correspond with span of target aircraft.
- Fly the aircraft so that the target appears within the gyro reticle circle and rotate the throttle twist grip until the diameter of the gyro reticle circle corresponds to the target size.
- Continue to frame the target with the gyro reticle circle by rotating the twist grip as range changes. Track the target smoothly for one second; then fire.
- Continue ranging and tracking while firing.

## Bombs

### Releasing Bombs

The following is a standard procedure for releasing bombs:

- Set the Bomb Arming switches to the ARM position.
- Set the Bomb-Rocket Selector switch to BOTH for simultaneous release or TRAIN for individual release.
- Press the Bomb-Rocket Release button on the control stick grip momentarily to release bombs. If the Bomb-Rocket Selector switch is set to TRAIN, the Bomb-Rocket Release button will release only the left bomb. Pressing the Bomb-Rocket Release button again will release the bomb on the right rack.

Note, bombs may be released when the aircraft is in any pitch attitude from a 30-degree climb to a vertical dive.

**Do not release bombs when you are sideslipping more than 5 degrees in a vertical dive. Doing so may collide a bomb and the propeller.**

### Emergency Bomb and Drop Tank Release

The Bomb Salvo handles, located aft of the instrument panel on the left side of the cockpit, can be used to release the bombs or drop tanks manually in the event of failure of the normal electrical release.

## Rockets

When firing rockets, the gunsight Gyro Selector switch should be set to FIXED.

## Firing Rockets

To fire rockets, perform the following steps:

- Turn the Rocket Counter dial to 1.
- Set the Bomb-Rocket Selector switch to ROCKETS.
- To nose-arm the rockets for delay upon impact, set the delay switch to DELAY.
- To fire rockets singly, set the Rocket Release Control switch to SINGLE and press the Bomb-Rocket Release button on the control stick once for each rocket.
- To fire all rockets in train (ripple), set the Rocket Release Control switch to AUTO and hold the Bomb-Rocket Release button depressed for approximately one second while the rockets are fired.

# RADIO COMMUNICATIONS



# RADIO COMMUNICATIONS

There are two optional modes of using the radio that depend on the "EASY COMMUNICATION" OPTION under the GAMEPLAY tab. This setting also determines the key commands used to access the radio menu in-game.

Because the SCR-522A VHF AM radio of the P-51 is limited to 5 channels, you will only be able to communicate with those entities whose frequencies are loaded in your radio. Radio frequencies are loaded in the mission editor by the mission designer and should be made available as part of the mission briefing.

## Easy Communication is enabled

The radio communications window is accessed by a press of the [↵] backslash key (this is for US keyboards, other language keyboards may vary). After the command selection the radio or interphone will be selected (if required) and tuned (if required) automatically. Also [↵] key will close radio command menu.

When the radio menu is displayed, recipients are color-coded as follows:

- Recipients on which at least one of the radios is tuned to are colored white.
- Recipients on which at least one of the radios can be tuned to but is not currently on the correct frequency are colored gray.
- Recipients that cannot be contacted due to range or terrain masking / earth curvature are colored black.

Each will also have their modulation / frequency listed. When you select a recipient, the appropriate radio will automatically be tuned to communicate with the selected recipient.

When Easy Communications mode is enabled, the following 'quick' command shortcuts are also available:

[LWIN + U] Request AWACS vector to home plate.

[LWIN + G] Command flight to attack ground targets.

[LWIN + D] Command flight to attack air defense targets.

[LWIN + W] Command flight to cover me.

[LWIN + E] Command flight to proceed with the mission and return to base.

[LWIN + R] Command flight to proceed with the mission and rejoin.

[LWIN + T] Command flight to open/close the formation.

[LWIN + Y] Command flight to rejoin the formation.

## Easy Communication is not enabled

When Easy Communications mode is OFF, the Push To Transmit (PTT) button [RALT + V] is used to open the radio command panel. The PTT button opens and closes the radio communications window for the currently selected radio.

When recipients are displayed, there is no color-coding of availability and no listing of their modulation / frequency. This is the more realistic play mode and requires you to know the correct modulation / frequencies for each recipient and you must manually enter the frequencies on the correct radio.

## Radio Communications Window

Top Level Recipient List:

If using "Easy Communications", recipients not present in the mission will not be listed.

- F1. Wingman...**
- F2. Flight...**
- F3. Second Element...**
- F4. JTAC...**
- F5. ATCs...**
- F7. AWACSeS...**
- F8. Ground Crew...**
- F10. Other...**
- F12. Exit**

Hotkeys will also be available to directly issue any command in the structure. These can be found in Input Options.

To exit radio communications, you can also press the ESC key.

## F1 Wingman

Upon selecting F1 Wingman from the main radio communications window, you have the option to select the basic type of message you wish to send to your number 2 wingman. These are:

- F1. Navigation...**
- F2. Engage...**
- F3. Engage with...**
- F4. Maneuvers...**



**F5. Rejoin Formation****F11. Previous Menu****F12. Exit**

## F1 Navigation...

The Navigation options allow you to direct where your wingman will fly to.

**F1. Anchor Here.** Your wingman will orbit at its current location until you issue a Rejoin command.

**F2. Return to base.** Your wingman will return to and land at the airbase designated in the flight plan.

**F11. Previous Menu****F12. Exit**

## F2 Engage...

The Engage options allow you to direct your wingman to attack a specific type of target. After issuing the order, the wingman will attempt to locate the specified target type and attack it.

**F1. Engage Ground Targets.** Wingman will attack any enemy ground unit it can locate.

**F2. Engage Armor.** Wingman will attack any tanks, infantry fighting vehicles, and armored personnel carriers it can locate.

**F3. Engage Artillery.** Wingman will attack any tube artillery or multiple rocket launchers that it can locate.

**F4. Engage Air Defenses.** Wingman will attack any enemy anti-aircraft artillery and surface to air missile units that it can locate.

**F5. Engage Utility Vehicles.** Wingman will attack all supply, transport, fuel, power generation, command and control, and engineering units it can locate.

**F6. Engage Infantry.** Wingman will attack hostile infantry units. Note that the infantry units are very difficult to detect unless they are moving or firing weapons.

**F7. Engage Ships.** Wingman will engage enemy surface combatants. Note that most surface combatants are heavily armed and that the P-51 is not well-suited to attacking such targets.

**F8. Engage Bandits.** Wingman will engage any enemy fixed-wing and rotary-wing aircraft it can locate.

**F11. Previous Menu****F12. Exit**

## F3 Engage With...

Whereas the F2 Engage command allows you to give basic orders for your wingman to attack a target type, the F3 Engage With set of commands not only allows you to determine target type, but also the direction of attack and what weapon type to use. This is done in a tiered manner by first selecting target type, then weapon type, and finally the attack heading. The wingman will then attempt to locate targets of the specified type and attack them according to your specified weapon and attacking heading. While the F2 Engage options are fast to issue, the F3 Engage With options provide much greater control.

**Target Type.** These options mirror those of the F2 Engage orders and allow you to determine the type of ground target you want your wingman to engage.

**F1. Engage Ground Targets.** Wingman will attack any enemy ground unit it can locate.

**F2. Engage Armor.** Wingman will attack any tanks, infantry fighting vehicles, and armored personnel carriers it can locate.

**F3. Engage Artillery.** Wingman will attack any tube artillery or multiple rocket launchers that it can locate.

**F4. Engage Air Defenses.** Wingman will attack enemy anti-aircraft artillery and surface to air missile units that it can locate.

**F5. Engage Utility Vehicles.** Wingman will attack all supply, transport, fuel, power generation, command and control, and engineering units it can locate.

**F6. Engage Infantry.** Wingman will attack hostile infantry units. Note that the infantry units are very difficult to detect unless they are moving or firing weapons.

**F7. Engage Ships.** Wingman will engage enemy surface combatants. Note that most surface combatants are heavily armed and that the P-51D is not well-suited to attacking such targets.

**Weapon Type.** Once you have selected the target type, you will be given a list of weapon types that you want your wingman to engage the target with. These include:

**F2. Unguided Bomb...**

**F4. Rocket...**

**F6. Gun...**

**Attack Heading.** After you've selected the weapon type for your wingman to use, the third and final step is to determine the attack heading that you wish your wingman to use. This can be useful to help it avoid overflying enemy defenses. The options include:

**F1. Default.** Wingman will use the most direct heading to attack the target.

**F2. North.** Wingman will attack the target from south to north.

**F3. South.** Wingman will attack the target from north to south.

**F4. East.** Wingman will attack the target from west to east.

**F5. West.** Wingman will attack the target from east to west.

## F4 Maneuvers...

Although your wingman will generally do a good job of knowing when and how to maneuver, there may be times when you want to give him/her a very specific maneuvering order. This could be in response to a threat or to better set up an attack.

**F1. Break Right.** This command will order your wingman to make a maximum-G break to the right.

**F2. Break Left.** This command will order your wingman to make a maximum-G break to the left.

**F3. Break High.** This command will order your wingman to make a maximum-G break high.

**F4. Break Low.** This command will order your wingman to make a maximum-G break low.

**F7. Clear Right.** Your wingman will perform a 360-degree turn to the right of the current flight path while searching for targets.

**F8. Clear Left.** Your wingman will perform a 360-degree turn to the left of the current flight path while searching for targets.

**F9. Pump.** Your wingman will perform a 180-degree turn from its current heading and fly 10 nm. Once reached, it will turn 180-degrees back to the original heading.

## F5 Rejoin Formation

Issuing this command will instruct your wingman to cease its current task and rejoin formation with you.

## F2 Flight

Upon selecting F2 Flight from the main radio communications window, you have the option to select the basic type of message you wish to send. These are:

**F1. Navigation...**

**F2. Engage...**

**F3. Engage with...**

**F4. Maneuvers...**

**F5. Formation**

**F6. Rejoin Formation**

**F11. Previous Menu**

**F12. Exit**

## F1 Navigation...

The Navigation options allow you to direct your flight where to fly to.

**F1. Anchor Here****F2. Return to base****F11. Previous Menu****F12. Exit**

These commands mirror those of the Wingman Navigation commands, but apply to all flight members.

## F2 Engage...

The Engage options allow you to direct your flight to attack a specific type of target. After issuing the order, the flight will attempt to locate the specified target type and attack it.

**F1. Engage Ground Target****F2. Engage Armor****F3. Engage Artillery****F4. Engage Air Defenses****F5. Engage Utility Vehicles****F6. Engage Infantry****F7. Engage Ships****F8. Engage Bandits****F11. Previous Menu****F12. Exit**

These commands mirror those of the Wingman Navigation commands, but apply to all flight members.

## F3 Engage With...

These commands mirror those of the Wingman Engage With commands, but apply to all flight members. These commands work the same as the Wingman Engage With Commands described above.

## F4 Maneuvers...

**F1. Break Right****F2. Break Left****F3. Break High****F4. Break Low**

**F7. Clear Right**

**F8. Clear Left**

**F9. Pump**

**F11. Previous Menu**

**F12. Exit**

These commands mirror those of the Wingman Maneuvers commands, but apply to all flight members.

## F5 Formation

From the Formation menu, you can select the formation that the flight will fly in relation to you as the flight leader.

**F1. Go Line Abreast**

**F2. Go Trail**

**F3. Go Wedge**

**F4. Go Echelon Right**

**F5. Go Echelon Left**

**F6. Go Finger Four**

**F7. Go Spread Four**

**F8. Open Formation**

**F9. Close Formation**

**F11. Previous Menu**

**F12. Exit**

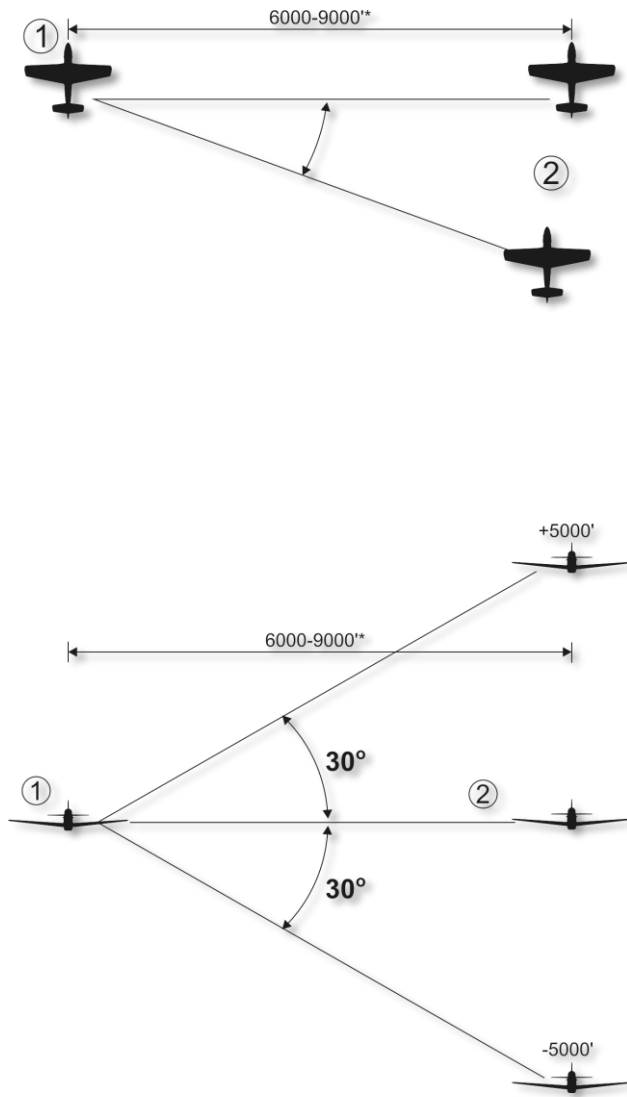

Figure 99: F1 Go Line Abreast



**Figure 100: F2 Go Trail**

Position may be modified within a 4000-12,000' envelope by flight lead.

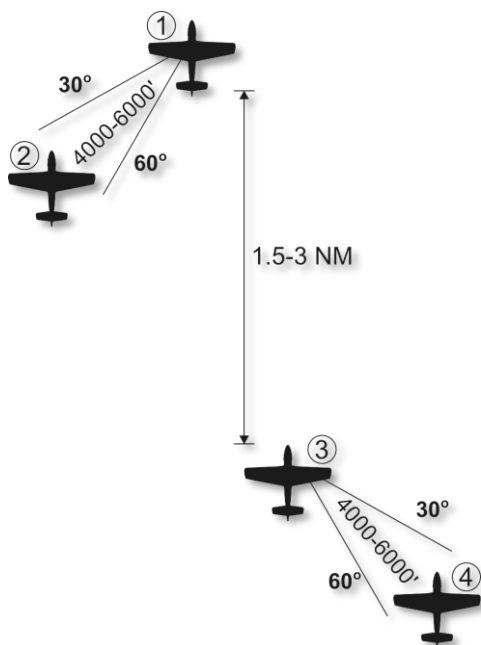

Figure 101: F3 Go Wedge



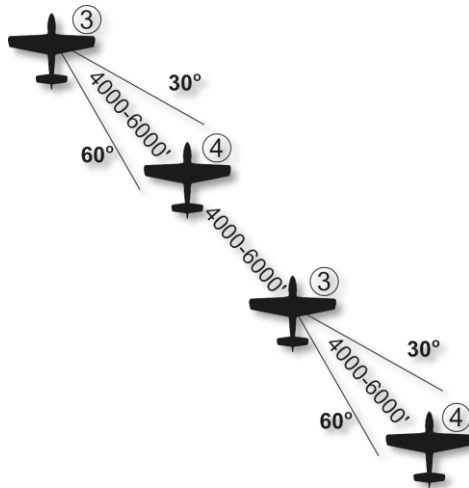

Figure 102: F4 Go Echelon Right

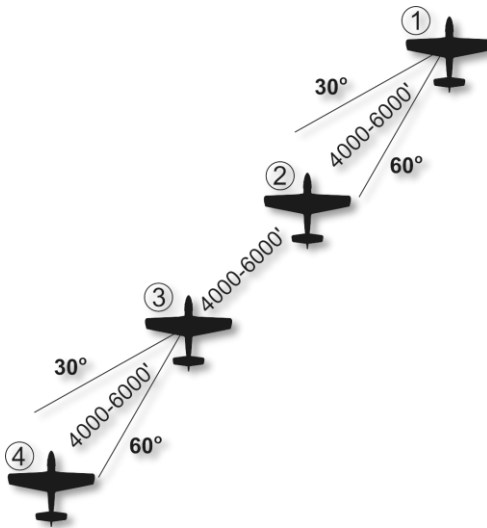
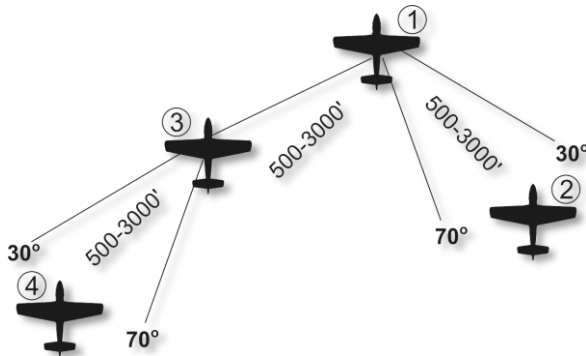

Figure 103: F5 Go Echelon Left



**Figure 104: F6 Go Finger Four**

Position may be modified within a 4000-12,000' envelope by flight lead.



**Figure 105: F7 Go Spread Four**

Position may be modified within a 4000-12,000' envelope by flight lead.

**F8. Open Formation.** Increase the distance between each aircraft in the current formation.

**F9. Close Formation.** Decrease the distance between each aircraft in the current formation.

## F6 Rejoin Formation

Issuing this command will instruct your flight to cease their current task and rejoin formation with you.

## F3 Second Element

Upon selecting F3 Second Element from the main radio communications window, you have the option to select the basic type of message you wish to send to the second element of your flight. The second element consists of flight members 3 and 4 with number 3 being the element lead. When

issuing a command to second element, number 3 and 4 carry out the order jointly. These commands are:

**F1. Navigation...**

**F2. Engage...**

**F3. Engage with...**

**F4. Maneuvers...**

**F5. Rejoin Formation**

**F6. Out**

**F11. Previous Menu**

**F12. Exit**

## F1 Navigation...

The Navigation options allow you to direct your second element where to fly to.

**F1. Anchor Here**

**F2. Return to base**

**F11. Previous Menu**

**F12. Exit**

These commands mirror those of the Wingman Navigation commands, but apply to the second element.

## F2 Engage...

The Engage options allow you to direct your second element to attack a specific type of target. After issuing the order, the wingman will attempt to locate the specified target type and attack it.

**F1. Engage Ground Target**

**F2. Engage Armor**

**F3. Engage Artillery**

**F4. Engage Air Defenses**

**F5. Engage Utility Vehicles**

**F6. Engage Infantry**

**F7. Engage Ships**

**F8. Engage Bandits**

**F11. Previous Menu**

## F12. Exit

These commands mirror those of the Wingman Maneuvers commands, but apply to the second element.

## F3 Engage with...

These commands mirror those of the Wingman Maneuvers commands, but apply to the second element.

## F4 Maneuvers...

Although your second element will generally do a good job of knowing when and how to maneuver, there may be times when you want to give him/her a very specific maneuvering order. This could be in response to a threat like an incoming SAM, or to better set up an attack.

### F1. Break Right

### F2. Break Left

### F3. Break High

### F4. Break Low

### F7. Clear Right

### F8. Clear Left

### F9. Pump

### F11. Previous Menu

### F12. Exit

These commands mirror those of the Wingman Maneuvers commands, but apply to the second element.

## F5 Rejoin Formation

Issuing this command will instruct your second element to cease its current task and rejoin formation with you.

## Flight Member Responses

After sending a radio message to any of your flight members, you will have one of two responses:

**Flight number of responder (2, 3, or 4).** When a flight member will carry out the order, it will respond simply with its flight number.

**(Flight member number) unable.** When a flight member cannot carry out the order, it will respond with its flight number following by "unable". For example: "2, unable"

## F4 JTAC

Depending on the battlefield situation, the level of JTAC control of the attack may vary. There are three types of terminal attack control:

**Type 1:** JTACs use Type 1 control when the risk assessment requires them to visually acquire the attacking aircraft and the target under attack. This is the most common and restrictive of the three types. Type 1 is most often used when friendly forces are "danger close".

**Type 2:** Type 2 control will be used when the JTAC desires control of individual attacks but assesses that either visual acquisition of the attacking aircraft or target at weapons release is not possible or when attacking aircraft are not in a position to acquire the mark/target prior to weapons release/launch.

**Type 3:** Type 3 control may be used when the tactical risk assessment indicates that CAS attack imposes low risk of fratricide. This is the least restricted control type.

In order to communicate with a JTAC, there must be at least one in the mission. Any unit can be assigned as a JTAC. JTACs are assigned a radio frequency that they need to be contacted on. For P-51 this must be VHF AM radio.

### JTAC Engagement Flow

To contact a JTAC, open the main radio menu ([**R**] or [**RALT** + **R**]). Press F4 to select JTACs from the Radio Main Menu.

After selecting "JTACs", a list of JTACs in the mission will be displayed, along with their frequencies and callsigns (if using Easy Communications). Select the JTAC that you wish to contact. If you are using realistic radio, you will need to ensure that the correct radio is tuned to the correct frequency that the JTAC is on (most often listed in Mission Briefing). If using Easy Communications, the correct radio and frequency will be set automatically. You will then be prompted to Check-in with the estimated time you will be available for tasking (Play Time).

When you check-in, you will automatically radio the JTAC key information that includes:

- Your mission number
- Location from Initial Point (IP) and your altitude
- What you are armed with
- How long you are available (hours + minutes)

You will then automatically ask what tasking the JTAC has for you.

After a pause, the JTAC will reply with the terminal control type (1, 2 or 3) that will be used and then ask if you are available for the 9-line. The 9-line is a standard briefing form that provides the pilot key information to prosecute the attack. When you are ready, press the [**R**] or [**RALT** + **R**] key to view the radio menu and then press F1 "Ready to copy".

The JTAC will now read the 9-line as follows:

1. The Initial Point (IP) that the attack should be started from. This is a point created in the Mission Editor.
2. Attack heading to the target and any offset needed
3. Distance to target
4. Elevation of target (MSL)
5. Target type
6. UTM coordinates of target
7. How the target is marked (None, White Phosphorus (WP), or IR Pointer)
8. Location of nearby friendly ground forces
9. Control point to egress to

After completing the 9-line, the JTAC will automatically ask if you are ready for remarks. Remarks are additional information not included in the 9-line. When ready, press [↵] or [RALT + ↵] and then [F1]. The JTAC will then radio the remarks, which generally include the weapon to use, weather information, and/or attack headings.

You will now need to read back the target location and elevation, and other data if applicable such as final attack heading. To do so, press [↵] and then [F1].

At this point, the engagement can vary according to how the JTAC designates the target: Coordinate, smoke, or IR pointer. We'll discuss each of these separately:

#### **Coordinate Only Designation:**

When the JTAC does not have line of sight to the target (often the case with Type 2 and 3), it will only be able to designate the target as a MGRS coordinate.

After receiving the point data, the JTAC will clear you to engage.

After your attack is complete, press [↵] or [RALT + ↵] and press [F1] "Attack Complete".

#### **Smoke Designation:**

After receiving the point data, the JTAC will ask you to report when you are IP inbound. When you are ready to proceed from the IP to the target, press [↵] or [RALT + ↵] and [F1] "IP Inbound" to start your attack. If you are inbound from the IP, the JTAC will then tell you to continue.

At this point, you need to wait for the JTAC to mark the target with smoke. When you are within 10 nm of the target, the target will be marked with white smoke and the JTAC will radio that the "mark is on the deck". Once you have a visual on the smoke, press [↵] or [RALT + ↵] and then [F1] "Contact the mark". The JTAC will then radio back the location of the target from the smoke marker.

Once heading toward the target, press [↵] or [RALT + ↵] and then [F1] "In" to indicate that you've started your attack run. If all looks good to the JTAC, he will clear you in hot. If not, he will abort the attack. Once you have released your weapon, press [↵] or [RALT + ↵] and then [F1] "Off".

Depending on the results of your attack, you will either be cleared to re-attack or cleared to depart. If cleared to re-attack, you need to start the process again from the IP Inbound stage of the attack.

**IR Pointer Designation:**

The IR Pointer, or IR Wand, replaces the smoke marker during low light conditions. To see the IR Pointer, you must have the Night Vision Goggles (NVG) on. The IR pointer appears as a line between the JTAC and the target.

As such, the process flow for the IR Pointer is the same as for the smoke marker. The only difference are the options for "Pulse" and "Rope" that instruct the JTAC to flash the IR Pointer on and off or move it around, respectively.

**Other JTAC Radio Options:**

During a JTAC directed attack, the JTAC menus allow some additional options not mentioned above. These include:

**Repeat Brief.** JTAC will repeat the 9-line briefing.

**What is my target?** JTAC will repeat the type of target that you are tasked to destroy.

**Contact.** This command is made to the JTAC to verify that the correct target is at the target location. You will report contact and provide a target description and MGRS coordinates. The JTAC will respond with a positive acknowledgment or with warning about contacting the wrong target. In its response, the JTAC also provide directions to the correct target.

**Request BDA.** JTAC will update you on the status of the directed target.

**Unable to comply.** Informs the JTAC that you are unable to carry out the instructed task.

**Check Out.** Ends JTAC control.

## F5 ATC

The Air Traffic Control (ATC) system of this simulation is context sensitive to the location of your aircraft: on the parking ramp or runway/airborne.

ATC VHF FM Contact Frequencies:

Anapa-Vityazevo: 121.0 MHz

Batumi: 131.0 MHz

Gelendzhik: 126.0 MHz

Gudauta: 130.0 MHz

Kobuleti: 133.0 MHz

Kopitnari: 134.0 MHz

Krasnodar Center: 122.0 MHz

Krasnodar-Pashkovsky: 128.0 MHz

Krymsk: 124.0 MHz

Maykop-Khanskaya: 125.0 MHz

Mineralnye Vody: 135.0 MHz

Mozdok: 137.0 MHz

Nalchik: 136.0 MHz

Novorossiysk: 123.0 MHz

Senaki-Kolkhi: 132.0 MHz

Sochi-Adler: 127.0 MHz

Soganlug: 139.0 MHz

Sukhumi-Babushara: 129.0 MHz

Tbilisi-Lochini: 138.0 MHz

Vaziani: 140.0 MHz

Beslan: 141.0 MHz

Because the SCR-522A VHF AM radio of the P-51 is limited to 5 channels, you will only be able to communicate with those entities whose frequencies are loaded in your radio. Radio frequencies are loaded in the mission editor by the mission designer and should be made available as part of the mission briefing.



### Parking Ramp Start

Before you can communicate with ATC/Ground Control to get permission to start your engine, you first need to have your VHF AM radio up and running.

With the radio now operating, press [↵] or [RALT + ↵] to bring up the radio menu and then press F1 "Request Engine Start".

If you have wingmen, they will also now start their engine.

After the aircraft has been started and configured, select [F1] "Request taxi to runway". Once you receive permission, you can taxi to the "hold short" area of the taxiway - the area on the taxiway just short of entering the runway.

If you have wingmen, they will also now taxi to the runway.

When at the hold short area, press [↵] or [RALT + ↵] and [F1] "Request takeoff". When permission is granted, you can taxi on to the runway and take off.

### Runway and Air Start

If you are not starting from the parking ramp, you can access ATC by pressing the [↵] or [RALT + ↵] key. Upon doing so, you can select [F5] "ATCs".

If you are using "Easy Communications", a list of airfield ATCs are listed along with their contact frequencies. Select the airfield ATC you wish to contact. If not using Easy Communications, you will first need to the push channel button of the assigned ATC frequency you wish to land on the radio.

Once the airfield ATC is selected, you can either send them an "Inbound" message to indicate that you intend to land there, or an "I'm lost" message that will result in the ATC providing you guidance to reach the airfield.

When you select "Inbound", the ATC will respond with the following information:

- Heading to fly to reach landing initial point.
- Range to landing initial point.
- The QFE, or atmospheric pressure at the airfield elevation.
- Which runway to land on.

You can then radio:

- "Request landing" indicates your intent to land at directed runway.
- "Abort landing" indicates that you will not be landing at the directed runway.
- "Request azimuth" requests navigation assistance to reach the airfield.

If you've requested landing and are on final approach, radio request landing a second time and ATC tower control will provide permission if the runway is clear. It will also provide wind direction and speed.

After you have landed, proceed to the parking area and shut down the aircraft.

## F7 AWACS

After selecting the F7 AWACS option from the main radio menu, a list of all friendly AWACS in the mission will be listed, along with their VHF AM contact frequencies. Upon setting your VHF AM radio accordingly and contacting the desired AWACS, you'll be given the following options:

**F1. Vector to bullseye.** Sending this request to AWACS will result in AWACS providing you heading and range to the bullseye/anchor point set for the mission.

**F2. Vector to home plate.** Sending this request to AWACS will result in AWACS providing you heading, range, and the ATC frequency of the mission specified landing airbase.

**F4. Request bogey dope.** AWACS will provide heading, altitude, and aspect of the nearest enemy aircraft.

**F5. Request Picture.** Sending this request to AWACS will result in AWACS providing you bearing, range, and altitude of known enemy air threats.

The AWACS response differs according to the range of enemy air groups:

- **If BULL (over 50 nm):** (Your flight's callsign), (AWACS callsign), new picture, <number of groups detected> groups. First group, bulls <bearing> for <range>, <altitude band>. Second group, bulls <bearing> for <range>, <altitude>. (repeats up to three groups)
- **If BRA (under 50 nm):** (Your flight's callsign), (AWACS callsign), new picture, <number of groups detected> groups. First group, bra <bearing> for <range>, hits <altitude band>. Second group, bra <bearing> for <range>, hits <altitude band>. (repeats up to three groups)

## F8 Ground Crew

After landing at a friendly airfield and taxiing to a parking ramp, you can communicate with the ground crew for rearming and refueling by pressing the F8 option to display the ground crew menu.

# SUPPLEMENTS

561

# SUPPLEMENTS

## Airbase Data

Airbase	Runway	TACAN, channel	ILS	Tower comm
UG23 Gudauta - Bambora (Abkhazia)	15-33, 2500m			130.0
UG24 Tbilisi - Soganlug (Georgia)	14-32, 2400m			139.0
UG27 Vaziani (Georgia)	14-32, 2500m	22X (VAS)	108.75	140.0
UG5X Kobuleti (Georgia)	07-25, 2400m	67X (KBL)	07 ILS - 111.5	133.0
UGKO Kutaisi - Kopitnari (Georgia)	08-26, 2500m	44X (KTS)	08 ILS - 109.75	134.0
UGKS Senaki - Kolkhi (Georgia)	09-27, 2400m	31X (TSK)	09 ILS - 108.9	132.0
UGSB Batumi (Georgia)	13-31, 2400m	16X (BTM)	13 ILS - 110.3	131.0
UGSS Sukhumi - Babushara (Abkhazia)	12-30, 2500m			129.0
UGTB Tbilisi - Lochini (Georgia)	13-31, 3000m		13 ILS - 110.3 31 ILS - 108.9	138.0
URKA Anapa - Vityazevo (Russia)	04-22, 2900m			121.0
URKG Gelendzhik (Russia)	04-22, 1800m			126.0
URKH Maykop - Khanskaya (Russia)	04-22, 3200m			125.0
URKI Krasnodar - Center (Russia)	09-27, 2500m			122.0
URKK Krasnodar - Pashkovsky (Russia)	05-23, 3100m			128.0
URKN Novorossiysk (Russia)	04-22, 1780m			123.0
URKW Krymsk (Russia)	04-22, 2600m			124.0
URMM Mineralnye Vody (Russia)	12-30, 3900m		12 ILS - 111.7 30 ILS - 109.3	135.0
URMN Nalchik (Russia)	06-24, 2300m		24 ILS - 110.5	136.0
URMO Beslan (Russia)	10-28, 3000m		10 ILS - 110.5	141.0
URSS Sochi - Adler (Russia)	06-24, 3100m		06 ILS - 111.1	127.0

XRMF Mozdok (Russia)	08-27, 3100m		137.0
----------------------	--------------	--	-------

## Morse Code Alphabet

Morse code	Alphabet	
	Russian	Latin
•—	А а	A a
—•••	Б б	B b
•— —	В в	W w
— — •	Г г	G g
— ••	Д д	D d
•	Е е	E e
•••—	Ж ж	V v
— — ••	З з	Z z
••	И и	I i
— • —	К к	K k
• — ••	Л л	L l
— —	М м	M m
— •	Н н	N n
— — —	О о	O o
• — — •	П п	P p
• — •	Р р	R r
•••	С с	S s
—	Т т	T t
•• —	У у	U u
•• — •	Ф ф	F f
••••	Х х	H h
— • — •	Ц ц	C c
— — — •	Ч ч	O o

----	Ш ш	Ch ch
--•-	Щ щ	Q q
-•--	Ы ы	Y y
••--	Ю ю	U u
•-•-	Я я	A a
•---	Й й	J j
-••-	Ь ь	X x
••••	Э э	E e

Morse code	Digits full
•----	1
••---	2
•••--	3
••••-	4
•••••	5
-••••	6
--•••	7
---••	8
----•	9
-----	0
Morse code	Digits brief
•-	1
••-	2
•••-	3
••••-	4
•••••	5
-••••	6

- • • •	7
- • •	8
- •	9
-	0

Morse code	Punctuation marks
• - • - • -	Full stop / Period (.)
- • - • - •	Semicolon (;)
- - - • • •	Colon (:)
• • • • • •	Point / Decimal separator (.)
• • - - • •	Question mark (?)
• - • • - •	Quotation mark ("")
- - • • - -	Comma (,)
- • - - •	Open parenthesis ((
- • - - • -	Close parenthesis ())

## Developers

### Eagle Dynamics

#### Management

Nick Grey	Project Director, Director of The Fighter Collection
Igor Tishin	Project Development Manager, Director of Eagle Dynamics, Russia
Andrey Chizh	Assistant Development & QA Manager, technical documentation
Alexander Babichev	Project manager
Matt "Wags" Wagner	Producer, game and technical documentation, game design
Jim "JimMack" MacKonochie	Producer
Eugene "EvilBivol-1" Bivol	Associate Producer
Matthias "Groove" Techmanski	Localization Management

#### Programmers

Dmitry Baikov	System, multiplayer, sound engine
Ilya Belov	GUI, map, input
Nikolay Brezin	Smoke effect, new model format support
Maxim Zelensky	AC, AI AC, flight dynamics, damage model
Andrey Kovalenko	AI AC, weapons
Ilya "Dmut" Levoshevich	AI vehicles, ships, triggers
Alexander Oikin	Avionics, aircraft systems
Evgeny Pod'yachev	Plugins, build system
Alexey Smirnov	Effects, graphics
Timur Ivanov	Effects, graphics



Konstantin Stepanovich	AI AC, radio, mission editor
Oleg "Olgerd" Tischenko	Avionics
Vladimir Feofanov	AI AC flight dynamics
Konstantin Tarakanov	GUI, mission editor
Sergey "Klen" Chernov	Weapons, Sensors
Alexey "Fisben" Shukailo	Avionics
Kirill Kosarev	AI ground units, installer, mission generator
Alexander "SFINX" Kurbatov	AI vehicles, ships
Eugene Gribovich	Avionics
Dmitri Robustov	Terrain
Denis Tatarnicev	Terrain
Alexey Petruchik	Terrain
Dmitri Kaplin	Terrain
Oleg "Legus" Pryad'ko	Weapons
Sergey "Lemon Lime" Chernov	Dynamic atmosphere

## Artists and Sound

Yury "SuperVasya" Bratukhin	AC, vehicles, weapons models
Alexander "Skylark" Drannikov	GUI graphic, AC models
Stanislav "Acgaen" Kolesnikov	Cockpit, AC, weapons models
Timur Tsigankov	AC, vehicles, ships, weapons models
Eugeny "GK" Khizhnyak	AC, vehicles
Pavel "DGambo" Sidorov	AC models
Constantine Kuznetsov	Sound engineer
Kirill Grushevich	Buildings, Terrain
Sergey "tama" Ashuiko	Buildings, Terrain
Konstantin Miranovich	Buildings, Terrain
Andrey "LISA" Reshetko	Characters

## Quality Assurance

Valery "USSR_Rik" Khomenok	Lead Tester
Ivan "Frogfoot" Makarov	Testing
Sergey "Foreman" Gusakov	Testing
Michael "Yurcha" Urevich	Testing
Andrey "Andrey Andreevich" Kryutchenko	Localization

## Science Support

Dmitry "Yo-Yo" Moskalenko	Mathematical models of dynamics, systems, ballistics
Alexander "PilotMi8" Podvoisky	Mission Editor Documentation

## IT and Customer Support

Alexander "Tez" Sobol	Customer support, WEB, forum
Konstantin "Const" Borovik	System and network administrator, WEB, forum
Andrey Filin	System and network administrator

## Third Parties

Zachary "luckybob9" Sesar – 3D models of watchtower, shelter, corrected model of the power lines pylon

Andrea "Heater" Papaleo – P-51D skins; Big Beautiful Doll, Ferocious Frankie, Miss Velma, Italian Air Force 1952

Thomas "Tomcatz" Schultz – Airshow Crowd

## Tester staff

Gavin "159th\_Viper" Torr  
Nikolay "Agm" Borisov  
Darrell "AlphaOneSix" Swoap  
Pascal "Cougar" Bidegare  
Carlos "Design" Pastor Mendez  
Guillaume "Dimebug" Leleve  
Valery "=FV=BlackDragon" Manasyan  
James "Eddie" Knight  
Kiko "Mistral" Becerra  
Daniel "EtherealN" Agorander  
Frank "Feuerfalke" Bender  
George "GGTharos" Lianeris  
Matthias "Groove" Techmanski  
Dmitry "Laivynas" Koshelev  
Zachary "Luckybob9" Sesar  
Ed "Manawar" Green  
Gennedy "Marks" Tagiltsev  
Michael "MoGas" Stobbe  
Stephen "Nate--IRL--" Barrett  
Craig "Nemises" Reynolds  
Jon Espen "Panzertard" Carlsen  
Roberto "Radar Rider" Benedi Garcia  
Maxim "RIMM" Boitsov  
Rick "rjetster" Ladomade  
Steve Davies  
Roberto "Vibora" Seoane Penas  
Erich "ViperVJG73" Schwarz  
Peter "Weta43" McAllister  
Paul "paulrkiii" Kempton  
Nick "BlueRidgeDX" Landolfi  
Evan "Headspace" Hanau  
Shawn "StrongHarm" Burton  
Jesus "mvgas" Gastonrivera  
Alexander "BillyCrusher" Bilievsky  
Christopher "Mustang" Wood  
Chris "Ells228" Ellis

Timothy "WarriorX" Westmore  
Werner "derelor" Siedenburg

Special thanks to all the Open Beta testers.

## Special thanks

Sergey Archakov for photos of P-51

Stephen "Nate IRL" Barrett for a big testing contribution